

# İŞ GÜVENLİĞİ KATALOĞU

PERSONAL PROTECTIVE EQUIPMENTS

EQUIPOS DE PROTECCION INDIVIDUAL

PERSÖNLICHE SCHUTZAUSRÜSTUNG

СРЕДСТВА ИНДИВИДУАЛЬНОЙ ЗАЩИТЫ

LA PROTECTION INDIVIDUELLE



[www.henesgrup.com](http://www.henesgrup.com)



İŞ GÜVENLİĞİ MALZEMELERİ

**İÇİNDEKİLER CONTENTS**

Sayfa / Page  
5

**KAFA KORUYUCULAR**  
HEAD PROTECTION



**GÖZ VE YÜZ KORUYUCULAR**  
EYE AND FACE PROTECTION

Sayfa / Page  
10

Sayfa / Page  
26

**GÖZ VE VÜCUT DUŞLARI**  
EMERGENCY SHOWERS



**İLK YARDIM**  
FIRST AID

Sayfa / Page  
36

Sayfa / Page  
40

**İŞİTME KORUYUCULAR**  
HEARING PROTECTION



**SOLUNUM KORUYUCULAR**  
RESPIRATORY PROTECTION

Sayfa / Page  
51

Sayfa / Page  
72

**EL KORUYUCULAR**  
HAND PROTECTION



**DÜŞME KORUYUCULAR**  
FALL PROTECTION

Sayfa / Page  
117

Sayfa / Page  
125

**VÜCUT KORUYUCULAR**  
WORKWEAR





**İÇİNDEKİLER** CONTENTS



**AYAK KORUYUCULAR**  
FOOT PROTECTION

Sayfa / Page  
**150**

Sayfa / Page  
**179**

**ELEKTRİK EKİPMANLARI**  
ELECTRICAL SAFETY



**YANGIN GÜVENLİĞİ**  
FIRE SECURITY

Sayfa / Page  
**184**

Sayfa / Page  
**190**

**ÇEVRE GÜVENLİĞİ**  
ENVIRONMENT SAFETY



**TRAFİK EKİPMANLARI**  
ROAD SAFETY

Sayfa / Page  
**202**



## K.K.D EN STANDARTLARI PPE EN STANDARDS



**Kafa Korumucularında EN Standartları**

- EN 397 BARET
- EN 443 İTFAİYECİ BARETİ
- EN 812 KORUYUCULU KASKET

**Kulak Korumucularında EN Standartları**

- EN 352 - 1 GÜRÜLTÜ ÖNLEYİCİ KULAKLIKLAR
- EN 352 - 2 GÜRÜLTÜ ÖNLEYİCİ KULAK TIKAÇLARI
- EN 352 - 3 GÜRÜLTÜ ÖNLEYİCİ KULAKLIKLAR (BARETE TAKILAN)

**Göz Korumucularında EN Standartları**

- EN 166 GÖZ KORUYUCUSU GENEL STANDARTI
- EN 167 OPTİK TEST METODLARI
- EN 168 OPTİK OLMAYAN DİĞER TEST METODLARI
- EN 169 KAYNAK FİLTRELERİ
- EN 170 ULTRAVİOLE FİLTRELER
- EN 171 İNFRARED FİLTRELER
- EN 172 GÜNEŞ IŞIĞI FİLTRELERİ (SANAYİ)
- EN 174 KAYNAÇI FİLTRELERİ
- EN 175 KAYNAK SİPERLERİ - BAŞLIKLAR
- EN 1731 TEL ÖRÜĞÜLÜ GÖZ VE YÜZ KORUYUCULARI (BARETE TAKILAN)
- EN 207/208 LAZER FİLTRELERİ
- EN 379 OTOMATİK KARARAN KAYNAÇI BAŞLIKLARI

**Solumun Sistemi Korumucularında EN Standartları**

- EN 136 TAM YÜZ MASKELERİ
- EN 137 SOLUMUN ÇIHAZLARI (TÜP VE SIRTLIKLAR)
- EN 138 TEMİZ HAVA BESEMELİ MASKELER
- EN 139 KOMPRESÖR HAVA BESEMELİ SÜREKLİ HAVA AKIŞLI REGÜLATÖRLÜ MASKELER
- EN 140 YARIM YÜZ MASKELERİ
- EN 14387 (EN 141) GAZ BUHAR FİLTRELERİ
- EN 143 PARTİKÜL (ZERREÇİK) MASKELERİ
- EN 149 BAKIM GEREKTİRMİYEN (DISPOSABLE) MASKELER
- EN 289 TEMİZ HAVA BESEMELİ (MOTORLU) BAŞLIKLAR
- EN 14593-1 KOMPRESÖRLÜ HAVA BESEMELİ HEM POZİTİF TALEP VALFLİ HEM DE SÜREKLİ HAVA AKIŞLI SIVİÇLİ MASKELER
- EN 14593-2 KOMPRESÖRLÜ HAVA BESEMELİ POZİTİF TALEP VALFLİ MASKELER
- EN 402 KAÇIŞ MASKELERİ (20 DAKİKALIK TÜPLÜ SIRTLIKSIZ BOYUNDAN BELE ASMALI)
- EN 1146 AÇIŞ MASKELERİ (10-15 DAKİKALIK TÜPLÜ SIRTLIKSIZ BOYUNDAN ASMALI)
- EN 403 KAÇIŞ MASKELERİ (BAŞLIK FİLTRELİ)
- EN 405 BAKIM GEREKTİRMİYEN (DEĞİŞİBİLİR FİLTRELERİ OLMAYAN) GAZ BUHAR MASKELERİ

**El Korumucuları EN Standartları**

- EN 420 GENEL AMAÇLI ELDİVENLER
- EN 374-1 KİMYASALLARA, MİKRO-ORGANİZMALARLA DAYANIKLI ELDİVENLER
- EN 374-2 KİMYASALLARA, MİKRO-ORGANİZMALARLA DAYANIKLI ELDİVENLER (2. KADEME) SIZMA DİRENÇLİ
- EN 374-3 KİMYASALLARA, MİKRO-ORGANİZMALARLA DAYANIKLI ELDİVENLER (3. KADEME) SIZMA DİRENÇLİ
- EN 381 ÇELİK (ÖRÜĞ) ELDİVENLER
- EN 388 MEKANİK DİRENÇLİ, ANTI STATİK ELDİVENLER

**Düşmeyi Önleme EN Standartları**

- EN 341 YÜKSEKTEN GÜVENLİ İNDİRİN SİSTEMLER / APARATLAR
- EN 353-1 DÜŞMEYİ ÖNLEYEN FREMLEME SİSTEMİ (DİKEY HAT ÜZERİNDE)
- EN 353-2 DÜŞMEYİ ÖNLEYEN FREMLEME SİSTEMİ (ESNEK ELASTİK HAT ÜZERİNDE)
- EN 354 EMNİYET HALATLARI (LANYARD)
- EN 355 YÜKSEKTEN ANI DÜŞMEYİ ÖNLEYİCİ ŞOK (ENERJİ) ABSORBÖRLERİ VE EMNİYET HALATLARI
- EN 358 BEL TİPİ EMNİYET KEMERİ VE EMNİYET HALATI (POZİSYON TUTMA)
- EN 360 YÜKSEKTEN ANI DÜŞMEYİ ÖNLEYİCİ, GERİ SARMALI (ATALETLİ) TİP MAKARALAR APARATLAR VE ÖRÜĞ KOLONLARI
- EN 361 PARASÜT TİPİ EMNİYET KEMERİ
- EN 362 EMNİYET KANÇALARI, KARABİNALAR
- EN 363 DÜŞMEYİ DURDURAN SİSTEMLER
- EN 795 YÜKSEKTEN DÜŞMEYE KARŞI KORUMA - ANKORAJ ÇIHAZLARI - TRİPODLAR - SABİT KANÇALANMA APARATLARI, ÇIHAZLARI
- EN 1496 KURTARMA TECHİZATI - KURTARMA AMAÇLI KALDIRMA DONANIMLARI (DÜŞME VE KAYMAYA KARŞI KORUMA - EMNİYET İPLERİ, KUŞAKLAR VE DÜŞMEYİ ÖNLEYİCİLER DAHİL)

**Gövdde Korumucularında EN Standartları**

- EN 340 GENEL İŞ ELBİSELERİ
- EN 342 EKSTREM SOĞUCA KARŞI KORUYUCU GİYSİ (-S C ALTI)
- EN 343 YAĞMURDAN KORUYUCU GİYSİLER, YAĞMURLIKLAR
- EN 14058 SÖBÜK (SERİKLİ) KILIM GİYSİSİ
- EN 348 ERGİMiŞ METAL SİÇRAMALARINA KORUYUCU GİYSİ
- EN 367 YÜKSEK İSİ VE AÇIK ALEVDEN KORUYUCU GİYSİ
- EN 463 KİMYASALLARA KARŞI KORUYUCU GİYSİ (SIVI SİÇRAMALARI)
- EN 464 KİMYASALLARA KARŞI KORUYUCU GİYSİ (SIVI VE GAZ)
- EN 467 SIVI KİMYASALLARA KARŞI VÜCUDUN BİR KISMINI KORUYUCU GİYSİLER (ÖNLÜKLER, BAŞLIKLAR VB.)
- EN 468 KİMYASALLARA KARŞI KORUYUCU GİYSİ (PÜSKÜRTME VE ZERREÇİKLERİN VÜCUDA GEÇMESİ)
- EN 469/AC YANGINLA MÜCADELEDE KULLANILAN KORUYUCU GİYSİLER
- EN 471-2093 REFLEKTİFLİ (FOSFORLU) VE YÜKSEK DÖRÜNÜRLÜDE HALZ GİYSİ
- EN 531 YÜKSEK İSİYA MARUZ KALAN ENDÜSTRİ ÇALIŞANLARI İÇİN GİYSİ (İTFAİYECİ VE KAYNAÇI ELBİSELERİ HARİCİ)
- EN 533 İSİYA VE (SINIRLI) ALEVİ KARŞI KORUYUCU GİYSİ
- EN 943-1 SIVI VE GAZ KİMYASALLARDAN KORUYUCU GİYSİ, GAZ ELBİSELERİ (SIZDIRMAZ; TİP 1, GAZ SIZDIRAN; TİP 2)
- EN 1148-5-2098 ANTİSTATİK GİYSİ
- EN 1073 RADYOAKTİF KİRLİLİĞE KARŞI GİYSİ
- EN 14605 SIVI KİMYASALLARA KARŞI VÜCUDUN SADECE BİR BÖLÜMÜNÜ KORUYAN GİYSİ
- EN 13998 KESİLMEYE VE BİÇAK BATHASINA KARŞI ÖNLÜK, PANTALON VE YELEK
- EN 863 MEKANİK (DELİNİMELE, KESİLMELERE VB.) KORUMA SAĞLAYAN GİYSİ

**AYAK Korumucuları EN Standartları**

- EN 20345 (EN 345) GÜVENLİK AYAKKABI 200 JÜL SİMF 1 - YALNIZ HANGİ DERİDEN OLANLAR
- S1 KORUYUCU BURUNLU, ANTI STATİK DARBE EMİCİLİ TOPUK
- S2 SU GEÇİRMEZLİK +S1 ÖZELLİKLERİ
- S3 KORUYUCU TABANLI +S2-S1 ÖZELLİKLERİ
- SİMF 2 - YALNIZ TABİ VE SENTETİK POLİMERDEN OLANLAR
- S4 ANTİSTATİK, DARBE EMİCİLİ TOPUK
- S5 KORUYUCU TABAN + S4
- EN 20346 (EN 346) PROFESYONEL KULLANIM AYAKKABI 100 JÜL SU GEÇİRMEZLİK METATERSAL KORUMA KESİLMELERE MUKAVEMET KORUYUCU BURUNSUZ GÜVENLİK AYAKKABI S1 İNDRÖKARBONLARA DAYANIKLI TABAN, ANTI-STATİK, DARBE EMİCİLİ TOPUK
- O2 SU GEÇİRMEZLİK +O1 ÖZELLİKLERİ
- O3 KORUYUCU TABAN +O2 +O1 ÖZELLİKLERİ
- İTFAİYECİLER İÇİN AYAK GIYECEKLERİ
- EN 15090



**KAFA**  
**KORUYUCULAR**  
HEAD  
PROTECTION



ARAN  
SAFETY

Order Nr.  
Sipariş Kodu  
138160-V

## ARAN SAFETY OYSTER BARET

20

Havalandırılmalı  
Ventilation



Vidalı Pratik Ayar  
Easy Adjustment Wheel/Ratchet



Tokalı Çene Bağı  
Chin Strap

Entegre Koruyucu Gözlük  
Integrated Safety Visor



Açıklama : 6 noktadan bağlı tekstil astarlı baret.  
Barete entegre koruyucu gözlük

Description : 6 points textile comfort harness helmet  
with safety visor

Renkler / Colors :

Ayarlama / Adjustment : Çevirme tip / Wheel ratchet

Astar / Suspension : Tekstil / Textile

Havalandırma / Ventilation : ✓

Çene bağı / Chin strap : ✓

Malzeme / Material : ABS

Standart / Certification : CE EN 397

Ağırlık / Weight : 500 gr

ARAN  
SAFETY

Order Nr.  
Sipariş Kodu  
138160

## ARAN SAFETY ENOKI BARET

Açıklama : 6 noktadan bağlı tekstil astarlı yönetici bareti

Description : 6 points textile comfort harness director helmet

Renkler / Colors : 

Ayarlama / Adjustment : Çevirme tip / Wheel ratchet

Astar / Suspension : Tekstil / Textile

Havalandırma / Ventilation : 

Çene bağı / Chin strap : 

Malzeme / Material : ABS

Standart / Certification : CE EN 397

Ağırlık / Weight : 500 gr



20

ARAN  
SAFETY

Order Nr.  
Sipariş Kodu  
138152

## ARAN SAFETY PORTO BARET

Açıklama : 4 noktadan bağlı tekstil astarlı ayarlı baret

Description : 4 points textile comfort harness helmet with wheel ratchet

Renkler / Colors : 

Ayarlama / Adjustment : Çevirme tip / Wheel ratchet

Astar / Suspension : Tekstil / Textile

Havalandırma / Ventilation : 

Çene bağı / Chin strap : 

Malzeme / Material : PE

Standart / Certification : CE EN 397

Ağırlık / Weight : 400 gr



Havalandırma  
Ventilation

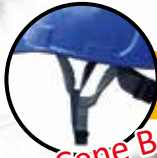

Tekstil Astar  
Textile Suspension

Tokalı Çene Bağı  
Chin Strap



20





ARAN  
SAFETY

Order Nr.  
Sipariş Kodu  
138121

## ARAN SAFETY WEST BARET



Açıklama : 6 noktadan bağlı plastik astarlı işçi bareti  
Description : 6 points plastic harness safety helmet

Renkler / Colors :

Ayarlama / Adjustment : Çevirme tip / Wheel ratchet

Astar / Suspension : Plastik / Plastic

Havalandırma / Ventilation :

Çene bağı / Chin strap :

Malzeme / Material : PE

Standart / Certification : CE EN 397

Ağırlık / Weight : 300 gr



ARAN  
SAFETY

Order Nr.  
Sipariş Kodu  
573007

## ARAN SAFETY KEP BARET

Açıklama : Kapalı alan hafif çalışma şartları için plastik gövdeli kep baret

Description : Safety bump cap fitted over a plastic shell providing lightweight head protection

Renkler / Colors :

Ayarlama / Adjustment : Cırtlı / Velcro

Havalandırma / Ventilation :

Malzeme / Material : %100 Pamuk & ABS  
%100 Cotton & ABS

Standart / Certification : CE EN 812

Ağırlık / Weight : 150 gr



Şok Emici Ped  
Soft Shock Absorber



**ARAN**  
SAFETY

Order Nr.  
Sipariş Kodu  
**14050**

## ARAN SAFETY BELLO DAĞCI BARETİ

20

Açıklama : 6 noktadan bağlı tekstil astarlı, yüksekte çalışma dağcı bareti

Description : Helmet with 6 points textile comfort harness specifically designed for rock climbing and mountaineering

Renkler / Colors :

Ayarlama Çevirme tip  
Adjustment : Wheel ratchet

Astar / Suspension : Tekstil / Textile

Havalandırma  
Ventilation : ✓

Çene bağı / Chin strap : ✓

Malzeme / Material : ABS

Standart / Certification : CE EN 397

Ağırlık / Weight : 500 gr



**ARAN**  
SAFETY

Order Nr.  
Sipariş Kodu  
**138114**

## ARAN SAFETY LEON BARET

Açıklama : 6 noktadan bağlı plastik astarlı işçi bareti

Description : 6 points plastic harness safety helmet

Renkler / Colors :

Ayarlama / Adjustment : Sürgü tip / Classic

Astar / Suspension : Plastik / Plastic

Havalandırma / Ventilation : ✓

Çene bağı / Chin strap : ✓

Malzeme / Material : PE

Standart / Certification : CE EN 397

Ağırlık / Weight : 300 gr





**GÖZ VE YÜZ**  
**KORUYUCULAR**  
EYE AND FACE  
PROTECTION



**Koruyucu Gözlükler**  
*Safety Spectacles*



**Goggle Tip Gözlükler**  
*Safety Goggles*



**Yüz Koruyucular**  
*Face Protection*

## Koruyucu Gözlükler Safety Spectacles

ARAN  
SAFETY



### ARAN SAFETY LUX GÖZLÜK

Order Nr.  
Sipariş Kodu  
608464



Açıklama : PC camlı, silikon burun pedli, geniş görüş açısına sahip koruyucu gözlük

Description : Safety eyewear with polycarbonate lens and silicone rubber nose pad

Lens renkleri

Lens Colors : Şeffaf / Clear

Uzunluk ayarlı saplar

Temple length adj. : ✓

Açı ayarlı saplar

Temple inclination adj. : ✗

Buğulanmaz / Anti-Fog : ✓

Standart / Certification : CE EN 166

300



Saklama Kılıfı  
With Case



Ekstra Yumuşak Burun Padi  
Extra Soft Nose Pad



300

ARAN  
SAFETY

### ARAN SAFETY NEPTUNE GÖZLÜK

Açıklama : PC camlı, geniş görüş açısına sahip, estetik koruyucu gözlük

Description :: Modern safety eyewear with polycarbonate lens

Lens renkleri Şeffaf, Gri

Lens Colors : Clear, Grey

Uzunluk ayarlı saplar

Temple length adj. : ✓

Açı ayarlı saplar

Temple inclination adj. : ✗

Buğulanmaz / Anti-Fog : ✓

Standart / Certification : CE EN 166



Order Nr.  
Sipariş Kodu  
608495



Order Nr.  
Sipariş Kodu  
608501



## Koruyucu Gözlükler Safety Spectacles



### ARAN SAFETY ERSİ GÖZLÜK

Açıklama : PC camlı, silikon burun pedli, geniş görüş açısına sahip koruyucu gözlük  
Description : Safety eyewear with polycarbonate lens and silicone rubber nose pad

Lens renkleri Şeffaf, Gri  
Lens Colors : Clear, Grey

Uzunluk ayarlı saplar  
Temple length : ❌

Açı ayarlı saplar  
Temple inclination adj. : ✅

Buğulanmaz / Anti-Fog : ✅

Standart  
Certification : CE EN 166



Order Nr.  
Sipariş Kodu  
**608518**



Order Nr.  
Sipariş Kodu  
**608525**



### ARAN SAFETY X-DESIGN GÖZLÜK

Açıklama : Modern tasarım PC cam ultra hafif koruyucu gözlük  
Description : Modern design eyewear with hardened polycarbonate lens

Lens renkleri Şeffaf, Gri, Sarı  
Lens Colors : Clear, Grey, Yellow

Standart / Certification : CE EN 166



Order Nr.  
Sipariş Kodu  
**662237**



Order Nr.  
Sipariş Kodu  
**661117**



Order Nr.  
Sipariş Kodu  
**662220**



## Koruyucu Gözlükler *Safety Spectacles*

**ARAN**  
SAFETY

Order Nr.  
Sipariş Kodu  
**180526**

### ARAN SAFETY VISITOR GÖZLÜK

Açıklama : Reçeteli gözlük üzerine kolayca takılabilen, geniş görüş açısına sahip ziyaretçi gözlüğü

Description : *The Visitor spectacle is a wrap-around spectacle providing a wide field of view and easy fit over prescription eyewear*

Lens renkleri / Lens Colors : Şeffaf / Clear

Standart / Certification : CE EN 166

300



**ARAN**  
SAFETY

Order Nr.  
Sipariş Kodu  
**608532**

### ARAN SAFETY URANUS GÖZLÜK

Açıklama : PC camlı, silikon burun pedli, geniş görüş açısına sahip üstün kenar korumalı koruyucu gözlük

Description : *Safety eyewear with polycarbonate lens and silicone rubber nose pad. It is designed for maximum impact resistance and superior side coverage*

Lens renkleri Şeffaf

Lens Colors : Clear

Buğulanmaz / Anti-Fog : ✓

Standart / Certification : CE EN 166



300



## Koruyucu Gözlükler Safety Spectacles

**ARAN**  
SAFETY

Order Nr.  
Sipariş Kodu  
**160016**

### ARAN SAFETY SAP AYARLI GÖZLÜK



300

Açıklama : Yekpare PC camlı, kenar korumalı koruyucu gözlük

Description : Single lens safety eyewear with side shields

Lens renkleri

Lens Colors : Şeffaf / Clear

Uzunluk ayarlı saplar

Temple length : ✓

Açı ayarlı saplar

Temple inclination adj. : ✗

Buğulanmaz / Anti-Fog : ✓

Standart / Certification : CE EN 166



**ARAN**  
SAFETY

Order Nr.  
Sipariş Kodu  
**160023**

### ARAN SAFETY SPORT GÖZLÜK



Açıklama : PC camlı, geniş görüş açısına sahip spor tip gözlük

Description : Sport design eyewear with wide visual angle

Lens renkleri

Lens Colors : Şeffaf / Clear

Açı ayarlı saplar

Temple inclination adj. : ✓

Standart / Certification : CE EN 166

300





## Koruyucu Gözlükler *Safety Spectacles*

ZEKLER  
PROTECT YOUR EYES



Order Nr.  
Sipariş Kodu  
**608900**

### ZEKLER 71 GÖZLÜK

Açıklama : Modern dizayn, PC camlı, kenar korumalı koruyucu gözlük

Description : *Lightweight safety spectacles in clean design with thin sidepieces*

Lens renkleri

Lens Colors : Şeffaf, Gri, Sarı / *Clear, Grey, Yellow*

Uzunluk ayarlı saplar

Temple length : ❌

Açı ayarlı saplar

Temple inclination adj. : ❌

Buğulanmaz / Anti-Fog : ✔️

Standart / Certification : CE EN 166, EN 170, EN 172



Order Nr.  
Sipariş Kodu  
**608920**

UV 400



Order Nr.  
Sipariş Kodu  
**608910**



### ZEKLER 31 GÖZLÜK



Açıklama : Yüze tam oturan, hafif ve rahat koruyucu gözlük

Description : *Lightweight and comfortable spectacles with optimal fit*

Lens renkleri Şeffaf, Sarı, Ayna

Lens Colors : *Clear, Yellow, Mirror*

Uzunluk ayarlı saplar

Temple length : ❌

Açı ayarlı saplar

Temple inclination adj. : ❌

Buğulanmaz / Anti-Fog : ✔️

Standart / Certification : CE EN 166, EN 170, EN 172



Order Nr.  
Sipariş Kodu  
**608700**



Order Nr.  
Sipariş Kodu  
**608710**



Order Nr.  
Sipariş Kodu  
**608720**



## Koruyucu Gözlükler Safety Spectacles



Order Nr.  
Sipariş Kodu  
608800



UV Protection

### ZEKLER 45 GÖZLÜK

Açıklama : Farklı lens seçenekleri ile çok fonksiyonlu koruyucu gözlük koruyucu gözlük

Description : Functional safety spectacles with several lens alternatives

Lens renkleri Şeffaf, Gri, Sarı, Turuncu

Lens Colors : Clear, Grey, Yellow, Orange

Uzunluk ayarlı saplar

Temple length : ✓

Açı ayarlı saplar

Temple inclination adj. : ✗

Buğulanmaz / Anti-Fog : ✓

Standart / Certification : CE EN 166, EN 170, EN 172

Order Nr.  
Sipariş Kodu  
608820



UV 400

Order Nr.  
Sipariş Kodu  
608810



UV Protection

Order Nr.  
Sipariş Kodu  
608830



UV Protection



## Koruyucu Gözlükler *Safety Spectacles*



### ZEKLER 25 GÖZLÜK



Açıklama : Kişisel optik gözlük üzerine takılabilen koruyucu gözlük

Description : *Safety spectacle intended for use over prescription eyewear*

Lens renkleri Şeffaf, Gri

Lens Colors : *Clear, Grey*

Uzunluk ayarlı saplar

Temple length : ✓

Açı ayarlı saplar

Temple inclination adj. : ✓

Buğulanmaz / Anti-Fog : ✓

Standart / Certification : CE EN 166, EN 170, EN 172



Order Nr.  
Sipariş Kodu  
**608600**



Order Nr.  
Sipariş Kodu  
**608620**

UV Protection





## Koruyucu Gözlükler Safety Spectacles

ARAN  
SAFETY



### ARAN SAFETY MILD GÖZLÜK

Order Nr.  
Sipariş Kodu  
**608471**



Açıklama : Modern tasarım  
PC cam hafif  
koruyucu gözlük

Description : Modern design  
eyewear with  
hardened  
polycarbonate lens

Lens renkleri / Lens Colors : Şeffaf / Clear

Buğulanmaz / Anti-Fog : ✓

Standart / Certification : CE EN 166

300

ARAN  
SAFETY



### ARAN SAFETY SATURN ÇİFT AMAÇLI GÖZLÜK

Order Nr.  
Sipariş Kodu  
**180557**



Açıklama : PC camlı, sızdırmaz sünger  
çerçevesi. Hem saplı hem  
lastik bantlı kullanılabilen  
gözlük

Description : Safety eyewear with polycarbonate lens and foam gasket. System allows the worker to choose either a strap or detachable sidepieces

Lens renkleri

Lens Colors : Şeffaf, Gri / Clear, Grey

Buğulanmaz / Anti-Fog : ✓

Standart / Certification : CE EN 166

Order Nr.  
Sipariş Kodu  
**180564**



## Goggle Tip Gözlükler *Safety Goggles*

**ARAN**  
SAFETY

Order Nr.  
Sipariş Kodu  
**608488**



### ARAN SAFETY GOGGLE

120



**Açıklama :** Çok geniş görüş açısına sahip panormaik PC camlı goggle tip gözlük. Ayarlanabilir baş bantı ile birlikte oldukça yumuşak PVC gövdeye sahip

**Description :** *Safety goggle designed with a wide-angle curved lens to enhance visibility. Adjustable headband and soft PVC frame provide added comfort*

**Havalandırma / Ventilation :** Dolaylı / Indirect

**Buğulanmaz / Anti-Fog :** ✓

**Standart / Certification :** CE EN 166



**ZEKLER**  
SAFETY

Order Nr.  
Sipariş Kodu  
**608550**

### ZEKLER 95 GOGGLE



1

**Açıklama :** Çok geniş görüş açısına sahip panormaik PC camlı goggle tip gözlük. Ayarlanabilir baş bantı ile birlikte oldukça yumuşak PVC gövdeye sahip

**Description :** *Safety goggle designed with a wide-angle curved lens to enhance visibility. Adjustable headband and soft PVC frame provide added comfort*

**Havalandırma / Ventilation :** Dolaylı / Indirect

**Buğulanmaz / Anti-Fog :** ✓

**Standart / Certification :** CE EN 166, EN 170





## Goggle Tip Gözlükler Safety Goggles

**ARAN**  
SAFETY

Order Nr.  
Sipariş Kodu  
**164427**

### ARAN SAFETY INDIRECT GOGGLE



200

Açıklama : Toz, partikül ve sıvı sıçramalarına karşı goggle tip gözlük. Ayarlanabilir baş bantı ile optik gözlük üzerine kullanılabilir

Description : Safety goggle for liquid splash protection. Ideal for anywhere eye protection is needed. Fits comfortably over most prescription glasses, adjustable with elastic headband

Havalandırma / Ventilation : Dolaylı / Indirect

Buğulanmaz / Anti-Fog : ✓ (164427-AF)  
✗ (164427)

Standart / Certification : CE EN 166



**ARAN**  
SAFETY

Order Nr.  
Sipariş Kodu  
**164434**

### ARAN SAFETY DIRECT GOGGLE



Açıklama : 164427 kodlu gözlük modeli direkt havalandırmalı

Description : Same as item 164427 with direct ventilation

Havalandırma / Ventilation : Direkt / Direct

Buğulanmaz / Anti-Fog : ✓ (164434-AF) ✗ (164434)

Standart / Certification : CE EN 166

200

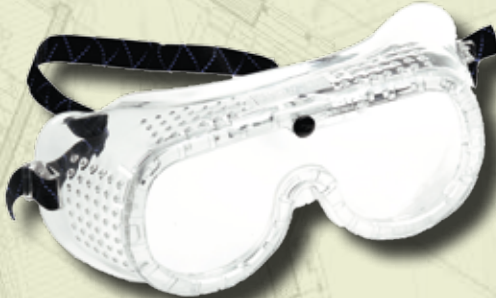



## Goggle Tip Gözlükler Safety Goggles



UV Protection



### ZEKLER 81 WELDING GOGGLE

ZEKLER  
PROTECT YOUR EYES

Order Nr.  
Sipariş Kodu  
608500



Açıklama : Son derece esnek ve rahat kaynak gözlüğü. Kaynak ışığı koruma sınıfı 3 ve 5

Description : Flexible safety spectacle with a good fit and welding filter refractive index 3 and 5

Havalandırma

Ventilation : Direkt / Direct

Buğulanmaz

Anti-Fog : ✓

Standart

Certification : CE EN 166, EN 169



ARAN  
SAFETY

Order Nr.  
Sipariş Kodu  
163000

### ARAN SAFETY WELDING GOGGLE



Açıklama : Göz ve çevresini koruyan koyu lensli kaynak gözlüğü. Açılır kapak sayesinde beyaz lens ile çalışma imkanı sunar

Description : Welding goggle protects the eyes and the eye area. The dark lens can be flipped open to show clear lens underneath

Havalandırma

Ventilation : Dolaylı / Indirect

Standart

Certification : CE EN 166, EN 169



## Yüz Koruyucular *Face Protection*

ARAN  
SAFETY

VİZÖR TEPE BAŞLIĞI

Order Nr.  
Sipariş Kodu  
19300-T

60



Standart / Certification : CE EN 166

ARAN  
SAFETY

BARETE TAKILIR VİZÖR YAYI

Order Nr.  
Sipariş Kodu  
607054

100



Standart / Certification : CE EN 166



Set Nasıl Yapılır? *How to Create your set?*





## Yüz Koruyucular *Face Protection*



ARAN  
SAFETY

### ARAN SAFETY VİZÖR CAMLARI

Açıklama : Vizör başlığı veya vizör yayı ile kullanılabilen cam seçenekleri

Description : Visor screens suitable for headgear and bracket

Ebat / Size : (h) 200 mm x (w) 400 mm

Standart

Certification : CE EN 166, EN 1731 (607207)



ZEKLER  
PROTECT YOUR HEARING

### ZEKLER 61A2 VİZÖR SET

Açıklama : ZEKLER 402 kulaklık ile entegre yüz koruyucu vizör seti

Description : ZEKLER visor combination with earmuff

Yalıtım / Insulation : 30 dB

Buğulanmaz / Anti-Fog : ✓

Ebat / Size : (h) 200 mm x (w) 200 mm

Standart / Certification : CE EN 166, EN 1731, EN 352-1

Order Nr.  
Sipariş Kodu  
193501



Order Nr.  
Sipariş Kodu  
193505

### ZEKLER VİZÖR CAMI





## Yüz Koruyucular Face Protection

**ARAN**  
SAFETY

Order Nr.  
Sipariş Kodu  
**143286**

### ARAN SAFETY HOBART KAYNAK MASKESİ

Açıklama : Açılır/kapanır ekranlı plastik kaynak başlığı

Description : Welding helmet with a retractable visor

Ayarlama / Adjustment : Çevirme tip / Wheel ratchet

Ekran ebatı / Screen size : (h) 50 mm x (w) 105 mm

Standart / Certification : CE EN 166, EN 175

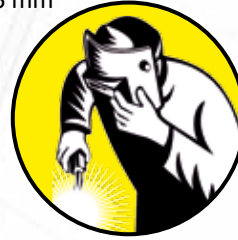

### EL KAYNAK MASKESİ

Açıklama : Plastik el kaynak maskesi

Description : Hand held plastic welding helmet

Ekran ebatı / Screen size : (h) 50 mm x (w) 105 mm

Standart / Certification : CE EN 166, EN 175

Order Nr.  
Sipariş Kodu  
**141381**



Yüz Koruyucular *Face Protection*



ARAN  
SAFETY

**BARETE TAKILIR KAYNAK MASKESİ**

Order Nr.  
Sipariş Kodu  
**628608**

Açıklama : Açılır/kapanır ekranlı barete takılır plastik kaynak başlığı  
Description : Welding helmet for hard hat attachment



Ekran ebatı / Screen size : (h) 50 mm x (w) 105 mm

Standart / Certification : CE EN 166, EN 175



Order Nr.  
Sipariş Kodu  
**272108**

**OTOMATİK KARARAN KAYNAK BAŞLIĞI**



Açıklama : Otomatik kararan ekranlı plastik kaynak başlığı  
Description : Plastic welding helmet with auto darkening screen

Standart / Certification : CE EN 379



**KAYNAK MASKE CAMI**

Order Nr.  
Sipariş Kodu  
**144085**



80 mm x 110 mm

Order Nr.  
Sipariş Kodu  
**144184**

**KAYNAK MASKE CAMI**

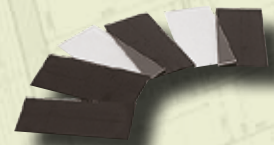

50 mm x 105 mm

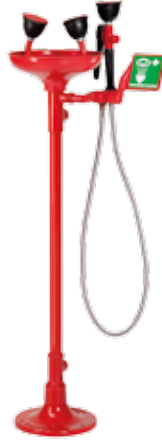

**GÖZ VE VÜCUT  
DUŞLARI  
EMERGENCY  
SHOWERS**



Seyyar Göz Duşu Şişeleri  
*Portable Eye Wash Bottles*



Çeşme Tipi Göz ve Vücut Duşları  
*Emergency Showers*



## Seyyar Göz Duşu Şişeleri *Portable Eye Wash Bottles*

plum

Order Nr.  
Sipariş Kodu  
**180663**

### PLUM GÖZ DUŞU SOLÜSYONU



Açıklama : % 0,9'luk steril sodyum klorür solüsyonu içerir

Description : 0,9 % sterile sodium chloride, similar to that of the human eye



Göz haznesi / Eye cups : ✓

Çift göze müdahale / DUO eye-cup : ✗

Kapasite / Capacity : 200 ml

Müdahale süresi / Wash time : 2 dk / 2 mins

plum

### PLUM GÖZ DUŞU SOLÜSYONU

Order Nr.  
Sipariş Kodu  
**180664**



Açıklama : % 0,9'luk steril sodyum klorür solüsyonu içerir

Description : 0,9 % sterile sodium chloride, similar to that of the human eye



Göz haznesi / Eye cups : ✓

Çift göze müdahale / DUO eye-cup : ✗

Kapasite / Capacity : 500 ml

Müdahale süresi / Wash time : 5 dk / 5 mins

B BRAUN

Order Nr.  
Sipariş Kodu  
**180670**

### BRAUN GÖZ DUŞU SOLÜSYONU



Açıklama : % 0,9'luk steril sodyum klorür solüsyonu içerir

Description : 0,9 % sterile sodium chloride, similar to that of the human eye



Göz haznesi / Eye cups : ✓

Çift göze müdahale / DUO eye-cup : ✗

Kapasite / Capacity : 500 ml

Müdahale süresi / Wash time : 5 dk / 5 mins

## Seyyar Göz Duşu Şişeleri *Portable Eye Wash Bottles*



### PLUM KİMYASAL GÖZ DUŞU SOLÜSYONU

plum

Order Nr.  
Sipariş Kodu  
180656

Açıklama : % 4,9'luk steril fosfat içerir

Description : 4,9 % sterile phosphate buffer for neutralisation of acid and base that come into contact with the eye

Göz haznesi / Eye cups : ✓

Çift göze müdahale / DUO eye-cup : ✗

Kapasite / Capacity : 200 ml

Müdahale süresi / Wash time : 2 dk / 2 mins



B BRAUN

Order Nr.  
Sipariş Kodu  
180687

### BRAUN KİMYASAL GÖZ DUŞU SOLÜSYONU



Açıklama : % 4,9'luk steril fosfat içerir

Description : 4,9 % sterile phosphate buffer for neutralisation of acid and base that come into contact with the eye

Göz haznesi / Eye cups : ✓

Çift göze müdahale / DUO eye-cup : ✗

Kapasite / Capacity : 250 ml

Müdahale süresi / Wash time : 2 dk / 2 mins



### GÖZ DUŞU SOLÜSYONU BEL ÇANTASI

Order Nr.  
Sipariş Kodu  
14692

Açıklama 200 / 250 ml 'lik şişe için kemer çantası

Description : Bag for 200 / 250 ml bottles



Gözlerinizi yıkamak bu kadar kolaydır!



Şişeyi askıdan yatay olarak alın.



Göz kupasını kapak kilidi kırılmaya kadar döndürün.



Başınızı geriye doğru eğin ve yıkayın.



Giysilerinizin ıslanmasından sakınmak istiyorsanız gerekirse başınızı öne eğin.



Önemli! Tüm hasar türlerinde göz yıkama sıvısı göze yumuşak ve eşit bir şekilde uygulanmalıdır. Şişeye sıkmadan hafifçe basın. Her zaman bir doktora başvurun ve yıkamaya nakil sırasında da devam edin.



## Seyyar Göz Duşu Şişeleri *Portable Eye Wash Bottles*

plum

Order Nr.  
Sipariş Kodu  
**18069**

### PLUM GÖZ DUŞU İSTASYONU

Açıklama : 1 adet 500 ml % 0,9'luk steril sodyum klorür solüsyonu içerir

Description : 1 bottle of 500 ml 0,9 % sterile sodium chloride

Ayna / Mirror : ❌

Kapak / Cover : ❌



plum

Order Nr.  
Sipariş Kodu  
**14802**

### PLUM DUO GÖZ DUŞU İSTASYONU

Açıklama : 1 adet 1.000 ml % 0,9'luk steril sodyum klorür solüsyonu içerir

Description : 1 bottle of 1.000 ml 0,9 % sterile sodium chloride

Ayna / Mirror : ✔️

Kapak / Cover : ❌

Çift göze müdahale *DUO*  
eye-cup : ✔️



plum

Order Nr.  
Sipariş Kodu  
**601205**

### PLUM AYNALI GÖZ DUŞU İSTASYONU

Açıklama : 2 adet 500 ml % 0,9'luk steril sodyum klorür solüsyonu içerir

Description : 2 bottles of 500 ml 0,9 % sterile sodium chloride

Ayna / Mirror : ✔️

Kapak / Cover : ❌





## Seyyar Göz Duşu Şişeleri *Portable Eye Wash Bottles*

plum

Order Nr.  
Sipariş Kodu  
18070

### PLUM AYNALI GÖZ DUŞU İSTASYONU

Açıklama : 2 adet 500 ml % 0,9'luk steril sodyum klorür solüsyonu içerir

Description : 2 bottles of 500 ml 0,9 % sterile sodium chloride

Ayna / Mirror : ✓

Kapak / Cover : ✓



B BRAUN

### BRAUN AYNALI GÖZ DUŞU İSTASYONU

Order Nr.  
Sipariş Kodu  
601229

Açıklama : 2 adet 500 ml % 0,9'luk steril sodyum klorür solüsyonu içerir

Description : 2 bottles of 500 ml 0,9 % sterile sodium chloride

Ayna / Mirror : ✓

Kapak / Cover : ✓



B BRAUN

Order Nr.  
Sipariş Kodu  
601304

### STILO AYNALI GÖZ DUŞU İSTASYONU

Açıklama : 2 adet 500 ml % 0,9'luk steril sodyum klorür solüsyonu içerir

Description : 2 bottles of 500 ml 0,9 % sterile sodium chloride

Ayna / Mirror : ✓

Kapak / Cover : ✗



Seyyar Göz Duşu Şişeleri *Portable Eye Wash Bottles*



plum

PLUM KOMBİNE GÖZ DUŞU İSTASYONU

Order Nr.  
Sipariş Kodu  
14787

Açıklama : 500 ml % 0,9'luk steril sodyum klorür solüsyonu ve 200 ml % 4,9'luk steril fosfat içerir

Description : 500 ml 0,9 % sterile sodium chloride and 200 ml 4,9 % sterile phosphate buffer



Ayna / Mirror : ✓

Kapak / Cover : ✓

B BRAUN

Order Nr.  
Sipariş Kodu  
601236

BRAUN KOMBİNE GÖZ DUŞU İSTASYONU

Açıklama / Description : 500 ml % 0,9'luk steril sodyum klorür solüsyonu ve 250 ml % 4,9'luk steril fosfat içerir

500 ml 0,9 % sterile sodium chloride and 250 ml 4,9 % sterile phosphate buffer



Ayna / Mirror : ✓

Kapak / Cover : ✓



B BRAUN

STILO KOMBİNE GÖZ DUŞU İSTASYONU

Order Nr.  
Sipariş Kodu  
601311

Açıklama : 500 ml % 0,9'luk steril sodyum klorür solüsyonu ve 250 ml % 4,9'luk steril fosfat içerir

Description : 500 ml 0,9 % sterile sodium chloride and 250 ml 4,9 % sterile phosphate buffer



Ayna / Mirror : ✓

Kapak / Cover : ✗



## Çeşme Tipi Göz ve Vücut Duşları *Emergency Showers*



### TOF SABİT / TAŞINABİLİR GÖZ DUŞU

Açıklama : Masa veya duvara monte edilebilir göz duşu

Description : *Emergency eyewash shower. Bench or wall mounted*

Göz haznesi

Eye cups : ✓

Çift göze müdahale

DUO eye-cup : ✗

El kumandası

Hand operation : ✓

Ayak kumandası

Foot operation : ✗

Kapasite / Capacity : 6 lt/dk / 6 lt/min

Standart

Certification : DIN EN 246



Order Nr.  
Sipariş Kodu  
1100/7



Order Nr.  
Sipariş Kodu  
1100/67



### TOF SABİT / TAŞINABİLİR GÖZ DUŞU

Açıklama : Masa veya duvara monte edilebilir göz duşu

Description : *Emergency eyewash shower. Bench or wall mounted*

Göz haznesi / Eye cups : ✓

Çift göze müdahale / DUO eye-cup : ✓

El kumandası / Hand operation : ✓

Ayak kumandası / Foot operation : ✗

Kapasite / Capacity : 12 lt/dk / 12 lt/min

Standart / Certification : DIN EN 246



Order Nr.  
Sipariş Kodu  
1100/60



Order Nr.  
Sipariş Kodu  
1100/42





Çeşme Tipi Göz ve Vücut Duşları *Emergency Showers*



TOF

TOF SEYYAR GÖZ DUŞU TANKI

Order Nr.  
Sipariş Kodu  
1100/250

Açıklama : Su kaynağına uzak ortamlar için seyyar göz duşu tankı  
Description : Portable eyewash shower for areas where there is no mains water supply



- Göz haznesi / Eye cups : ✓  
Çift göze müdahale / DUO eye-cup : ✗  
El kumandası / Hand operation : ✓  
Ayak kumandası / Foot operation : ✗  
Tank kapasitesi / Tank capacity : 18 lt  
Hava basıncı / Charging pressure : 6 bar  
Standart / Certification : DIN EN 246

TOF

Order Nr.  
Sipariş Kodu  
1100/300

TOF DUVARA MONTE GÖZ DUŞU



Açıklama : Duvara monte çanaklı göz duşu  
Description : Wall mounted eye-washer with bowl



- Göz haznesi / Eye cups : ✓  
Çift göze müdahale / DUO eye-cup : ✓  
El kumandası / Hand operation : ✓  
Ayak kumandası / Foot operation : ✗  
Kapasite / Capacity : 12 lt/dk / 12 lt/min  
Standart / Certification : DIN EN 246



## Çeşme Tipi Göz ve Vücut Duşları Emergency Showers

**TOF**

Order Nr.  
Sipariş Kodu  
1100/325

### TOF SABİT / TAŞINABİLİR YERE MONTE GÖZ DUŞU



Açıklama : Yere monte çanaklı göz ve vücut duşu  
Description : Floor mounted body shower and eye-washer with bowl



Göz haznesi / Eye cups : ✓

Çift göze müdahale / DUO eye-cup : ✓

El kumandası / Hand operation : ✓

Ayak kumandası / Foot operation : ✗

Kapasite / Capacity : 12 lt/dk / 12 lt/min

Standart / Certification : DIN EN 246

Boy Duşu  
Body Shower



Order Nr.  
Sipariş Kodu  
1100/320



### TOF YERE MONTE GÖZ DUŞU

Açıklama : Yere monte çanaklı göz duşu  
Description : Floor mounted eye-washer with bowl

Göz haznesi / Eye cups : ✓

Çift göze müdahale / DUO eye-cup : ✓

El kumandası / Hand operation : ✓

Ayak kumandası / Foot operation : ✓ (1100/330)

Kapasite / Capacity : 12 lt/dk / 12 lt/min

Standart / Certification : DIN EN 246



Order Nr.  
Sipariş Kodu  
1100/330



## Çeşme Tipi Göz ve Vücut Duşları *Emergency Showers*

TOF



Order Nr.  
Sipariş Kodu  
**1100/370**



### TOF YERE MONTE GÖZ VE VÜCUT DUŞU

Açıklama : Yere monte çanaklı göz ve vücut duşu

Description : Floor mounted shower and eye-washer with bowl

Göz haznesi / Eye cups : ✓

Çift göze müdahale / DUO eye-cup : ✓

El kumandası / Hand operation : ✓

Ayak kumandası / Foot operation : ✓ (1100/380)

Göz duşu kapasitesi

Eye washer capacity : 12 lt/dk / 12 lt/min

Vücut duşu kapasitesi

Shower capacity : 30 lt/dk / 30 lt/min

Standart / Certification : DIN EN 246



Order Nr.  
Sipariş Kodu  
**1100/380**

TOF

Order Nr.  
Sipariş Kodu  
**1100/480**

### TOF ARINMA PLATFORMU

Açıklama : Yere monte platform kontrollü arınma duşu

Description : Platform operated decontamination shower

Göz haznesi / Eye cups : ✓

Çift göze müdahale / DUO eye-cup : ✓

El kumandası / Hand operation : ✓

Platform kumandası / Platform operation : ✓

Kapasite / Capacity : 12 lt/dk / 12 lt/min

Vücut duşu kapasitesi / Shower capacity : 30 lt/dk / 30 lt/min

Standart / Certification : DIN EN 246

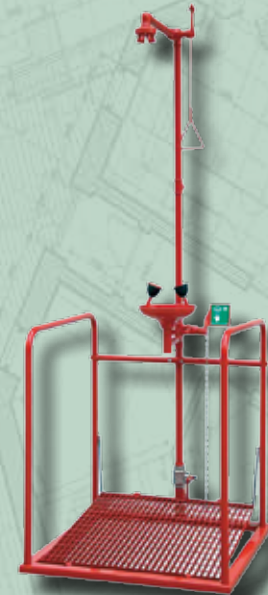





**İLK YARDIM**

FIRST AID

ARAN  
SAFETY

Order Nr.  
Sipariş Kodu  
810027

## ARAN SAFETY İLK YARDIM DOLABI

10

Açıklama : Seyyar ilk yardım dolabı

Description : Portable first aid station

Ebat / Size : (h) 450 mm x 300 mm x 100 mm

Malzeme / Material : Plastik (ABS)

Duvara montaj

Wall mounting : ✓

İçi dolu / Filled : ✓

Renkler / Colors :



ARAN  
SAFETY

Order Nr.  
Sipariş Kodu  
840079

## ARAN SAFETY İLK YARDIM ÇANTASI

12

Açıklama : Seyyar ilk yardım çantası

Description : Portable first aid station

Ebat / Size : (h) 320 mm x 220 mm x 130 mm

Malzeme / Material : Plastik (ABS)

Duvara montaj

Wall mounting : ✓

İçi dolu / Filled : ✓

Renkler / Colors :



Order Nr.  
Sipariş Kodu  
810010

## ECZA DOLABI

10

Açıklama : Sürgü camlı sabit ecza dolabı

Description : Stable first aid station with sliding cover

Ebat / Size : (h) 310 mm x 470 mm x 90 mm

Malzeme / Material : Plastik-Cam / Plastic-Glass

Duvara montaj / Wall mounting : ✓

İçi dolu / Filled : ✗





plum

Order Nr.  
Sipariş Kodu  
**80015**

## PLUM İLK YARDIM İSTASYONU



Açıklama : Geniş içerikli ilk yardım istasyonunu

Description : First aid station with a wide assortment of first aid products

Ebat / Size : (h) 430 mm x 253 mm x 92 mm

Kapak / Cover : ✓

Duvara montaj / Wall mounting : ✓

Yanık jeli / Burn gel : ✓

Göz duşu / Eye wash : ✓

Sargı bezi / Wound dressing : ✓

Yara temizleme bezi / Wound cleaning wipes : ✓

Yara bandı / Plaster : ✓



## YARA BANDI DAĞITICI DISPENSER



Order Nr.  
Sipariş Kodu  
**80001**

Açıklama : Küçük yaralanmalar için pratik yara bandı dağıtıcısı

Description : The dispenser provides easy, quick and hygienic relief for minor injuries and allows for use of plaster

Ebat / Size : (h) 135 mm x 230 mm

Kapasite / Capacity : 90 Yara bandı / 90 Plasters

Duvara montaj / Wall mounting : ✓

Su geçirmez / Water proof : ✓

Detektör algılayabilir / Detectable : ✓ (80002)

İçi dolu / Filled : ✓

Order Nr.  
Sipariş Kodu  
**80002**



Order Nr.  
Sipariş Kodu  
**80010**

## YEDEK DOLUM PAKETLERİ

Order Nr.  
Sipariş Kodu  
**80020**

Açıklama / Description : Dağıtıcı dispenser uyumlu yara bandı dolum paketi  
Refill pack for dispenser

Kapasite / Capacity : 45 Yara bandı / 45 Plasters

Detektör algılayabilir / Detectable : ✓ (80002)

Order Nr.  
Sipariş Kodu  
**830004**

## BASKET SEDYE

Açıklama : Basket sedye  
Description : Straight basket stretcher

Maksimum ebat / Max. size : 216 cm x 61 cm

Minimum ebat / Min. size : 216 cm x 61 cm

Ağırlık / Weight : 12 kg

Kapasite / Capacity : 272 kg

Standart / Certification : EN 1865

Katlanabilir / Foldable : ❌

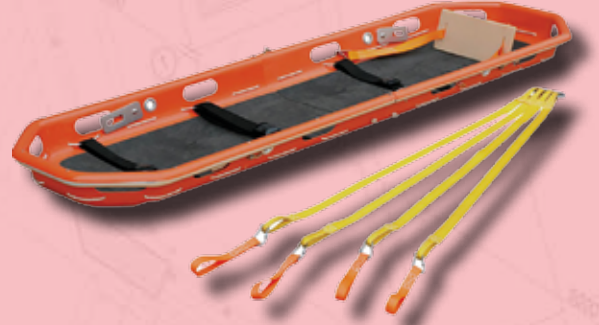

Order Nr.  
Sipariş Kodu  
**810008**

## KAŞIK SEDYE

Açıklama : Alüminyum çukur sedye  
Description : Aluminum rescue stretcher

Maksimum ebat / Max. size : 205 cm x 44 cm

Minimum ebat / Min. size : 165 cm x 44 cm

Ağırlık / Weight : 9 kg

Kapasite / Capacity : 150 kg

Standart / Certification : EN 1865

Katlanabilir / Foldable : ❌



Order Nr.  
Sipariş Kodu  
**830003**

## KATLANIR SEDYE

Açıklama : İkiye katlanır sedye  
Description : Dual fold stretcher for compact storage

Maksimum ebat / Max. size : 230 cm x 55 cm

Minimum ebat / Min. size : 96 cm x 50 cm

Ağırlık / Weight : 6 kg

Kapasite / Capacity : 150 kg

Standart / Certification : EN 1865

Katlanabilir / Foldable : ✔️



**Katlanır-Dizayn**  
Folding Design





**İŞİTME**  
**KORUYUCULAR**  
HEARING  
PROTECTION



**Kulak Tıkaçları**  
*Ear Plugs*



**Gürültü Önleyici Kulaklıklar**  
*Ear Muffs*



## Kulak Tıkaçları Ear Plugs



### ARAN SAFETY KULAK TIKACI

- Açıklama : Polipropilen, yumuşak kulak tıkacı  
Description : PU foam, soft ear plug
- Yalıtım / Insulation : 37 dB
- İpli / Corded : ✓ (19295)
- Kutulu / Storing box : ✗
- Yıkabilir / Washable : ✗
- Standart / Certification : EN 352-2



Order Nr.  
Sipariş Kodu  
**19295**



Order Nr.  
Sipariş Kodu  
**19293**



### QUIET KULAK TIKACI

- Açıklama : Şekil değiştirmeyen köpük kaplı kulak tıkacı  
Description : No rolling required foam-covered ear plug
- Yalıtım / Insulation : 28 dB
- İpli / Corded : ✓
- Kutulu / Storing box : ✓
- Yıkabilir / Washable : ✓
- Standart / Certification : EN 352-2

Order Nr.  
Sipariş Kodu  
**192208**



## Kulak Tıkacıları Ear Plugs

Order Nr.  
Sipariş Kodu  
**19231**

### KUTULU KULAK TIKACI

Açıklama : Poliüretan, yıkanabilir kulak tıkacı  
Description : Polyurethane foam ear plug for multiple use

100

Yalıtım / Insulation : 29 dB

İpli / Corded : ✓

Kutulu / Storing box : ✓

Yıkanabilir / Washable : ✓

Standart / Certification : EN 352-2

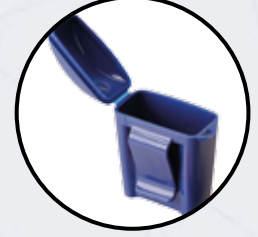

### ARAN SAFETY KULAK TIKACI DAĞITICI DISPENSER

Açıklama : Yeniden doldurulabilen, pratik kulak tıkacı dağıtıcısı  
Description : Easy refill ear plug dispenser for fast dispensing

Kapasite / Capacity : 500 Çift / 500 Pairs

Duvara montaj / Wall mounting : ✓

İçi dolu / Filled : ✗

ARAN  
SAFETY

Order Nr.  
Sipariş Kodu  
**301112**

1

Order Nr.  
Sipariş Kodu  
**192995**

### DISPENSER DOLUM PAKETİ

Açıklama / Description : Polipropilen, yumuşak kulak tıkacı  
PU foam, soft ear plug

Yalıtım / Insulation : 37 dB

Kapasite / Capacity : 200 Çift / 200 Pairs

Standart / Certification : EN 352-2





## Gürültü Önleyici Kulaklıklar Ear Muffs



### INTER GÜRÜLTÜ ÖNLEYİCİ KULAKLIK

Order Nr.  
Sipariş Kodu  
**12300**

Açıklama : Sentetik köpük dolgulu minderleri ile ayarlanabilir baş bantlı gürültü önleyici kulaklık

Description : Ear defender with ABS cups. Pads filled with synthetic foam. Double plastic headband (POM), adjustable in height, with metallic insert and soft, ventilated reinforcement for a better comfort



Yalıtım / Insulation : 33 dB

Ayarlanabilir bant  
Adjustable head fitting : ✓

Standart / Certification : EN 352-1



### Desibel Seviyeleri Decibel Levels





## Gürültü Önleyici Kulaklıklar Ear Muffs

Order Nr.  
Sipariş Kodu  
**007900**



**ZEKLER**  
PROTECT YOUR EARS

### ZEKLER 412RD KULAKLIK



Açıklama : FM Radyolu ve dış ses duyarlı profesyonel kulaklık

Description : Comfortable earmuffs with built-in stereo FM radio and level-dependent monitoring function

Yalıtım / Insulation : 30 dB

Ayarlanabilir bant / Adjustable head fitting : ✓

Değişebilir minderler / Replaceable cushions : ✓

Standart / Certification : EN 352-1, EN 352-4,  
EN 352-6, EN 352-8



**2**



### ZEKLER 412RDH BARETE TAKILIR KULAKLIK

**ZEKLER**  
PROTECT YOUR EARS

Order Nr.  
Sipariş Kodu  
**007901**

Açıklama : FM Radyolu ve dış ses duyarlı profesyonel barete takılır kulaklık

Description : Comfortable earmuffs with built-in stereo FM radio and level-dependent monitoring function for hard hat attachment

Yalıtım / Insulation : 29 dB

Ayarlanabilir bant  
Adjustable head fitting : ✓

Değişebilir minderler  
Replaceable cushions : ✓

Standart / Certification : EN 352-3, EN 352-4, EN 352-6, EN 352-8



## Gürültü Önleyici Kulaklıklar *Ear Muffs*

### *Elektronik Fonksiyonlar* Electronic Functions



**YALITIM SEVİYESİ**  
ATTENUATION LEVEL

2

**DAHİLİ FM RADYO**  
INTERNAL FM RADIO



**MP3 AUX GİRİŞİ**  
MP3 AUX INPUT



**DIŞ SES DUYARLI**  
LEVEL DEPENDENT SYSTEM



**ZEKLER**  
PROFESYONEL KULAKLIKLER

Order Nr.  
Sipariş Kodu  
007999

### **ZEKLER 402N ENSE BANTLI KULAKLIK**

2

**Açıklama :** Yüksek, orta ve düşük frekanslarda üstün yalıtım sağlayan ense bantlı profesyonel kulaklık. Ense bantı şapka ve baret ile birlikte kullanım imkanı sağlar

**Description :** Comfortable earmuffs with neckband for more demanding noisy environments. Suitable for using with cap or hard hat. Good attenuation across medium, high and low frequencies

**Yalıtım / Insulation :** 30 dB

**Ayarlanabilir bant / Adjustable head fitting :** ✓

**Değişebilir minderler / Replaceable cushions :** ✓

**Standart / Certification :** EN 352-1





## Gürültü Önleyici Kulaklıklar Ear Muffs

**ZEKLER**  
PROTECT YOUR EARS

Order Nr.  
Sipariş Kodu  
**007599**

### ZEKLER 403 KULAKLIK

3

Açıklama : Orta ve düşük frekanslarda üstün yalıtım sağlayan baş bantlı profesyonel kulaklık

Description : Comfortable earmuffs with headband fitting with exceptional attenuation across medium and low frequencies

Yalıtım / Insulation : 33 dB

Ayarlanabilir bant  
Adjustable head fitting : ✓

Değişebilir minderler  
Replaceable cushions : ✓

Standart / Certification : EN 352-1



20

**ZEKLER**  
PROTECT YOUR EARS

3

### ZEKLER 403H BARETE TAKILIR KULAKLIK

Order Nr.  
Sipariş Kodu  
**007899**

Açıklama : Orta ve düşük frekanslarda üstün yalıtım sağlayan barete takılır profesyonel kulaklık

Description : Comfortable earmuffs with hard hat attachment with exceptional attenuation across medium and low frequencies

Yalıtım / Insulation : 31 dB

Ayarlanabilir bant  
Adjustable head fitting : ✓

Değişebilir minderler  
Replaceable cushions : ✓

Standart / Certification : EN 352-3

20





## Gürültü Önleyici Kulaklıklar *Ear Muffs*



2

### ZEKLER 402 KULAKLIK

Açıklama : Yüksek, orta ve düşük frekanslarda üstün yalıtım sağlayan baş bantlı profesyonel kulaklık

Description : Comfortable earmuffs with headband fitting with exceptional attenuation across high, medium and low frequencies

Yalıtım / Insulation : 30 dB

Ayarlanabilir bant  
Adjustable head fitting : ✓

Değişebilir minderler  
Replaceable cushions : ✓

Standart / Certification : EN 352-1

ZEKLER  
PROTECT YOUR EARS

Order Nr.  
Sipariş Kodu  
007499



ZEKLER  
PROTECT YOUR EARS

Order Nr.  
Sipariş Kodu  
007799

### ZEKLER 402H KULAKLIK

Açıklama : Yüksek, orta ve düşük frekanslarda üstün yalıtım sağlayan barete takılır profesyonel kulaklık

Description : Comfortable earmuffs with hard hat attachment with exceptional attenuation across high, medium and low frequencies

Yalıtım / Insulation : 29 dB

Ayarlanabilir bant  
Adjustable head fitting : ✓

Değişebilir minderler  
Replaceable cushions : ✓

Standart / Certification : EN 352-3

2



## Gürültü Önleyici Kulaklıklar Ear Muffs



1

### ZEKLER 401 KULAKLIK

Açıklama : Orta ve yüksek frekanslarda üstün yalıtım sağlayan baş bantlı profesyonel kulaklık

Description : Comfortable earmuffs with headband fitting with exceptional attenuation across medium and high frequencies

Yalıtım / Insulation : 26 dB

Ayarlanabilir bant  
Adjustable head fitting : ✓

Değişebilir minderler  
Replaceable cushions : ✓

Standart / Certification : EN 352-1

ZEKLER  
PROTECT YOUR HEARING

Order Nr.  
Sipariş Kodu  
007399

20



ZEKLER  
PROTECT YOUR HEARING

Order Nr.  
Sipariş Kodu  
007699

### ZEKLER 401H KULAKLIK

1

Açıklama : Orta ve yüksek frekanslarda üstün yalıtım sağlayan barete takılır profesyonel kulaklık

Description : Comfortable earmuffs with hard hat attachment with exceptional attenuation across medium and high frequencies

Yalıtım / Insulation : 25 dB

Ayarlanabilir bant  
Adjustable head fitting : ✓

Değişebilir minderler  
Replaceable cushions : ✓

Standart / Certification : EN 352-3



20



## Gürültü Önleyici Kulaklıklar *Ear Muffs*



**ARAN**  
SAFETY

Order Nr.  
Sipariş Kodu  
**191065**

### ARAN SAFETY BASIC KULAKLIK

Açıklama : Gürültü önleyici kulaklık  
Description : Reduce loud factory noise to the level of  
a normal conversation

Yalıtım / Insulation : 25 dB

Ayarlanabilir bant  
Adjustable head fitting : ✓

Standart / Certification : EN 352-1



**ARAN**  
SAFETY

Order Nr.  
Sipariş Kodu  
**191409**

### ARAN SAFETY BARETE TAKILIR KULAKLIK

Açıklama : Tüm baretlere uyumlu barete takılır  
gürültü önleyici kulaklık

Description : Earmuff will fit virtually all slotted hard  
hats

Yalıtım / Insulation : 23 dB

Ayarlanabilir bant  
Adjustable head fitting : ✓

Standart / Certification : EN 352-3





## Gürültü Önleyici Kulaklıklar Ear Muffs

**ARAN**  
SAFETY

Order Nr.  
Sipariş Kodu  
**191164**

### ARAN SAFETY KAFA YASTIKLI KULAKLIK

Açıklama : Yüksek sesli çalışma ortamları için ideal, konforlu, kafa yastıklı kulaklık

Description : Ear defender provides protection from loud sounds and noises, and prevents hearing injuries

Yalıtım / Insulation : 25 dB

Ayarlanabilir bant  
Adjustable head fitting : ✓

Standart / Certification : EN 352-1



**ARAN**  
SAFETY

### ARAN SAFETY KATLANIR KULAKLIK

Order Nr.  
Sipariş Kodu  
**310503**

Açıklama : Yüksek sesli çalışma ortamları için ideal, konforlu kulaklık. Katlanabilir tasarımı size yer kazandıracaktır

Description : Ear defender with extra soft comfortable foam filled cups. Space saving folding design

Yalıtım / Insulation : 29 dB

Ayarlanabilir bant  
Adjustable head fitting : ✓

Standart / Certification : EN 352-1



**Katlanır-Dizayn**  
Folding Design



**SOLUNUM**  
**KORUYUCULAR**  
RESPIRATORY  
PROTECTION

► **Toz Maskeleri**  
*Disposable Respirators*

► **Yarım Yüz Maskeler**  
*Half Face Masks*

► **Tam Yüz Maskeleri**  
*Full Face Masks*

► **Solunum Setleri**  
*Self-Contained Breathing Apparatus*

► **Kaçış Maskeleri**  
*Escape Hoods*

► **Motorlu Solunum Üniteleri**  
*Fan Units*

► **Unite Başlıkları**  
*Face Pieces*

► **Hava Beslemeli Sistemler**  
*Supplied Air Respirators*

## Toz Maskeleri *Disposable Respirators*

**ARAN**  
SAFETY

Order Nr.  
Sipariş Kodu  
**444123**

### ARAN SAFETY RAVA 110 FFP1 NR D



360

Açıklama : Toz, katı ve sıvı parçacıkların zararlı etkilerinden korur

Description : Designed to protect respiratory system against harmful effect of dusts, solid and liquid aerosols

Sınır değer / Exposure limit : Max 4xOEL

Akıllı ventil / Exhaust valve : **X**

Ayarlanabilir bant / Adjustable head band : **✓**

Pratik tokalı bant / Detachable head band : **X**

Sızdırmaz bant çerçeve / Absorbent sealing : **X**

Standart / Certification : EN 149 FFP1



**ARAN**  
SAFETY

Order Nr.  
Sipariş Kodu  
**444130**

### ARAN SAFETY RAVA 110V FFP1 NR D



360

Açıklama : Toz, katı ve sıvı parçacıkların zararlı etkilerinden korur

Description : Designed to protect respiratory system against harmful effect of dusts, solid and liquid aerosols

Sınır değer / Exposure limit : Max 4xOEL

Akıllı ventil / Exhaust valve : **✓**

Ayarlanabilir bant  
Adjustable head band : **✓**

Pratik tokalı bant  
Detachable head band : **X**

Sızdırmaz bant çerçeve  
Absorbent sealing : **X**

Standart / Certification : EN 149 FFP1





Toz Maskeleri *Disposable Respirators*

ARAN  
SAFETY



ARAN SAFETY RAVA 220 FFP2 NR D

Order Nr.  
Sipariş Kodu  
444222



Açıklama : Toz, katı ve sıvı parçacıkların zararlı etkilerinden korur

Description : Designed to protect respiratory system against harmful effect of dusts, solid and liquid aerosols



Sınır değer / Exposure limit : Max 10xOEL

Akıllı ventil / Exhaust valve : ❌

Ayarlanabilir bant  
Adjustable head band : ✅

Pratik tokalı bant  
Detachable head band : ❌

Sızdırmaz bant çerçeve  
Absorbent sealing : ❌

Standart / Certification : EN 149 FFP2

ARAN  
SAFETY

Order Nr.  
Sipariş Kodu  
444253

ARAN SAFETY RAVA 240SV FFP2 NR D



Açıklama : Toz, katı ve sıvı parçacıkların zararlı etkilerinden korur  
Description : Designed to protect respiratory system against harmful effect of dusts, solid and liquid aerosols



Sınır değer  
Exposure limit : Max 10xOEL

Akıllı ventil  
Exhaust valve : ✅

Ayarlanabilir bant  
Adjustable head band : ✅

Pratik tokalı bant  
Detachable head band : ✅

Sızdırmaz bant çerçeve  
Absorbent sealing : ✅

Standart  
Certification : EN 149 FFP2



ACTIVATED  
CARBON  
AKTIF  
KARBONLU

Order Nr.  
Sipariş Kodu  
444260



## Toz Maskeleri *Disposable Respirators*

ARAN  
SAFETY

Order Nr.

Sipariş Kodu  
**444314**



### ARAN SAFETY RAVA 340SV FFP3 NR D

Açıklama : Toz, katı ve sıvı parçacıkların zararlı etkilerinden korur

Description : Designed to protect respiratory system against harmful effect of dusts, solid and liquid aerosols



Sınır değer / Exposure limit : Max 30xOEL

Akıllı ventil / Exhaust valve : ✓

Ayarlanabilir bant / Adjustable head band : ✓

Pratik tokalı bant / Detachable head band : ✓

Sızdırmaz bant çerçeve / Absorbent sealing : ✓

Standart / Certification : EN 149 FFP3



### Kendimize En Uygun RAVA Maskeyi Nasıl Seçeriz?

	RAVA 110	RAVA 110 V	RAVA 220	RAVA 240 SV	RAVA 340 SV
EN 149:2001+A1:2009	FFP1 R D		FFP2 R D		FFP3 R D
RAVA SERİSİ YARIM MASKE ÖZELLİKLERİ					
Ayarlanabilir burun klipsi	✓	✓	✓	✓	✓
Sağlığa uygun materyal	✓	✓	✓	✓	✓
Akıllı valf	-	✓	-	✓	✓
Ayarlanabilir baş bandı	✓	✓	✓	✓	✓
Tokalı baş bandı	-	-	-	✓	✓
Emici kenar bandı	-	-	-	✓	✓
RAVA SERİSİ YARIM MASKE PERFORMANS DEĞERLERİ					
95l/dk debide gaz yağlı ve tuz sızdırma oranı	< %20		< %6		< %1
95l/dk debide başlangıç solunum direnci	< 210 Pa		< 240 Pa		< 300 Pa
RAVA SERİSİ YARIM MASKE KULLANIMI					
Kullanım değeri	RAVA FFP1 maskeler çalışma ortamındaki sınır değeri 4xOEL geçmeyen tozların, katı ve sıvı parçacıkların zararlı etkilerinden korumak amacıyla kullanılır		RAVA FFP2 maskeler çalışma ortamındaki sınır değeri 10xOEL geçmeyen tozların, katı ve sıvı parçacıkların zararlı etkilerinden korumak amacıyla kullanılır		RAVA FFP3 maskeler çalışma ortamındaki sınır değeri 30xOEL geçmeyen tozların, katı ve sıvı parçacıkların zararlı etkilerinden korumak amacıyla kullanılır
Örnek uygulama alanları	Polenler, Sıva, Alçı, Çimento, Talaş Tozları		Kaynak, Krom, Asbest, Titanyum, Lehim, Cila, Ahşap Tozları		Kadmiyum, Nikel, Strikn, Radyoaktif Parçacıklar, Kalsiyum Karbonat
TERİMLER					
OEL: Mesleki Maruz Kalma Üst Limiti R: Çok Kullanımlı D: Dolomit Test Onayı					



## Toz Maskeleri *Disposable Respirators*

ARAN  
SAFETY

Order Nr.  
Sipariş Kodu  
444406

### ARAN SAFETY RAVA 510 FFP1 NR

FFP 1

200

Açıklama : Toz, katı ve sıvı parçacıkların zararlı etkilerinden korur, katlanabilir toz maskesi

Description : Folding respirator designed to protect respiratory system against harmful effect of dusts, solid and liquid aerosols

Sınır değer / Exposure limit : Max 4xOEL

Akıllı ventil / Exhaust valve : ✗

Ayarlanabilir bant / Adjustable head band : ✗

Pratik tokalı bant / Detachable head band : ✗

Sızdırmaz bant çerçeve / Absorbent sealing : ✗

Standart / Certification : EN 149 FFP1



ARAN  
SAFETY

### ARAN SAFETY RAVA 510V FFP1 NR

FFP 1

Order Nr.  
Sipariş Kodu  
444413

Açıklama : Toz, katı ve sıvı parçacıkların zararlı etkilerinden korur, katlanabilir toz maskesi

Description : Folding respirator designed to protect respiratory system against harmful effect of dusts, solid and liquid aerosols

Sınır değer / Exposure limit : Max 4xOEL

Akıllı ventil / Exhaust valve : ✓

Ayarlanabilir bant  
Adjustable head band : ✗

Pratik tokalı bant  
Detachable head band : ✗

Sızdırmaz bant çerçeve  
Absorbent sealing : ✗

Standart / Certification : EN 149 FFP1



100



## Toz Maskeleri *Disposable Respirators*

ARAN  
SAFETY

Order Nr.  
Sipariş Kodu  
444505

FFP 2

### ARAN SAFETY RAVA 520 FFP2 NR

Açıklama : Toz, katı ve sıvı parçacıkların zararlı etkilerinden korur, katlanabilir toz maskesi

Description : *Folding respirator designed to protect respiratory system against harmful effect of dusts, solid and liquid aerosols*

200

Sınır değer / Exposure limit : Max 10xOEL

Akıllı ventil / Exhaust valve : ❌

Ayarlanabilir bant / Adjustable head band : ❌

Pratik tokalı bant / Detachable head band : ❌

Sızdırmaz bant çerçeve / Absorbent sealing : ❌

Standart / Certification : EN 149 FFP2



ARAN  
SAFETY

Order Nr.  
Sipariş Kodu  
444512

### ARAN SAFETY RAVA 520V FFP2 NR

FFP 2

Açıklama : Toz, katı ve sıvı parçacıkların zararlı etkilerinden korur, katlanabilir toz maskesi

Description : *Folding respirator designed to protect respiratory system against harmful effect of dusts, solid and liquid aerosols*

100

Sınır değer / Exposure limit : Max 10xOEL

Akıllı ventil / Exhaust valve : ✓

Ayarlanabilir bant / Adjustable head band : ❌

Pratik tokalı bant / Detachable head band : ❌

Sızdırmaz bant çerçeve / Absorbent sealing : ❌

Standart / Certification : EN 149 FFP2



## Toz Maskeleri *Disposable Respirators*

ARAN  
SAFETY

Order Nr.  
Sipariş Kodu  
444529

### ARAN SAFETY RAVA 520V FFP2 ODOUR

FFP 2

ACTIVATED  
CARBON

AKTİF  
KARBONLU

100

Açıklama : Ekstra aktif karbon katmanı kaynak dumanı, solvent bazlı buharlar ve ağır kokulara karşı koruyucudur

Description : The layer of active carbon protects the respiratory tract from the simultaneous irritating effect of aerosols and vapours of organic substances with the concentration level lower than the OEL

Sınır değer / Exposure limit : Max 10xOEL

Akıllı ventil / Exhaust valve : ✓

Ayarlanabilir bant / Adjustable head band : ✗

Pratik tokalı bant / Detachable head band : ✗

Sızdırmaz bant çerçeve / Absorbent sealing : ✗

Standart / Certification : EN 149 FFP2

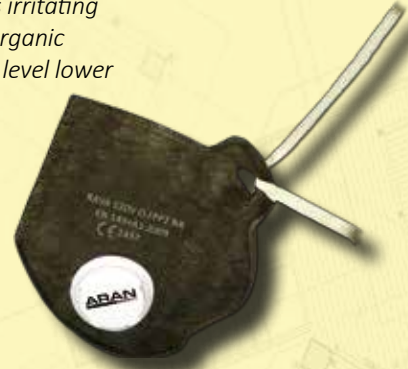

ARAN  
SAFETY

Order Nr.  
Sipariş Kodu  
444611

### ARAN SAFETY RAVA 530V FFP3 NR

FFP 3

Açıklama : Toz, katı ve sıvı parçacıkların zararlı etkilerinden korur, katlanabilir toz maskesi

Description : Folding respirator designed to protect respiratory system against harmful effect of dusts, solid and liquid aerosols

100

Sınır değer / Exposure limit : Max 30xOEL

Akıllı ventil / Exhaust valve : ✓

Ayarlanabilir bant / Adjustable head band : ✗

Pratik tokalı bant / Detachable head band : ✗

Sızdırmaz bant çerçeve / Absorbent sealing : ✗

Standart / Certification : EN 149 FFP3





## Yarım Yüz Maskeler Half Face Masks

Sundström

Order Nr.  
Sipariş Kodu  
73938

### SUNDSTRÖM SR 900 YARIM YÜZ MASKE



**Açıklama :** Daha rahat nefes verme için plastik ızgara koruyuculu çift hava valfine sahip yarım yüz maske

**Description :** The mask is equipped with two exhalation valves, which ensures very low exhalation resistance. Valve covers with baffles effectively protect the exhalation membrane against dust and paint mist

**Malzeme / Material :** Termoplastik / Thermoplastic

**Filtre sayısı / Filter :** 1

**Akıllı ventil sayısı / Exhaust valve :** 2

**Ayarlanabilir bant / Adjustable head band :** ✓

**Filtre koruyucu ped / Pre filter :** ✓

**Test diski / Test Disc :** ✓

**Standart / Certification :** EN 140





## Yarım Yüz Maskeler *Half Face Masks*

Sundström

Order Nr.  
Sipariş Kodu  
**73921**



### SUNDSTRÖM SR 100 YARIM YÜZ MASKE

**Açıklama :** Daha rahat nefes verme için plastik ızgara koruyuculu çift hava valfine sahip yarım yüz maske

**Description :** The mask is equipped with two exhalation valves, which ensures very low exhalation resistance. Valve covers with baffles effectively protect the exhalation membrane against dust and paint mist

**Malzeme / Material :** Silikon / Silicone

**Filtre sayısı / Filter :** 1

**Akıllı ventil sayısı / Exhaust valve :** 2

**Ayarlanabilir bant / Adjustable head band :** ✓

**Filtre koruyucu ped / Pre filter :** ✓

**Test diski / Test Disc :** ✓

**Standart / Certification :** EN 140



## Yarım Yüz Maskeler Half Face Masks

Sundström



### SUNDSTRÖM SR 90 YARIM YÜZ MASKE

Order Nr.  
Sipariş Kodu  
**73922**

Açıklama : Daha rahat nefes verme için plastik ızgara koruyuculu çift hava valfine sahip yarım yüz maske  
Description : The mask is equipped with two exhalation valves. Valve covers with baffles effectively protect the exhalation membrane against dust and paint mist



Malzeme / Material : Termoplastik / Thermoplastic

Filtre sayısı / Filter : 1

Akıllı ventil sayısı  
Exhaust valve : 2

Ayarlanabilir bant  
Adjustable head band : ✓

Filtre koruyucu ped / Pre filter : ✓

Test diskisi / Test Disc : ✓

Standart / Certification : EN 140

Sundström

### SUNDSTRÖM FİLTRELER / SUNDSTRÖM FILTERS

Order Nr.  
Sipariş Kodu  
**73926**



SR 510 P3 FİLTRE

Uyumlu maskeler SR 90, SR 100  
Designed for : SR 900, SR 200

Order Nr.  
Sipariş Kodu  
**73928**



SR 217 A1 FİLTRE

Standart  
Certification : EN 14387

Order Nr.  
Sipariş Kodu  
**73927**



SR 218 A2 FİLTRE

Order Nr.  
Sipariş Kodu  
**73929**



SR 297 A1B1E1K1 FİLTRE





## Yarım Yüz Maskeler *Half Face Masks*

sorbent®

Order Nr.  
Sipariş Kodu  
**809601**

### UNIX YARIM YÜZ MASKE

Açıklama : Her yüz boyuna uyum sağlayabilen oldukça rahat ve düşük maliyetli bir çözüm  
Description : Comfortable and high elasticity material that provides excellent protection, comfort and fit

Malzeme / Material : Termoplastik / Thermoplastic

Filtre sayısı / Filter : 2

Akıllı ventil sayısı / Exhaust valve : 1

Ayarlanabilir bant / Adjustable head band : ✓

Standart / Certification : EN 140

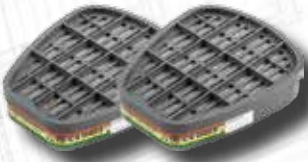

sorbent®

Order Nr.  
Sipariş Kodu  
**80970**

### UNIX A1B1E1K1 FİLTRE

Uyumlu maskeler / Designed for : UNIX, MAG-2

Standart / Certification : EN 143



### Filtre Üzerindeki Renkler Ne Anlama Geliyor? Description of Filter Colors

RENK / COLOR	SEMBOL SYMBOL	KORUMA SINIFI / PROTECTION
Kahverengi	AX	Organik bileşenlere ait gaz ve buharlar, kaynama derecesi <65°C
Kahverengi	A	Organik bileşenlere ait gaz ve buharlar, kaynama derecesi >65°C
Gri	B	İnorganik gazlar ve buharlar klor, hidrojen sülfür, hidrosiyanik asit, vb.
Sarı	E	Sülfür dioksit, hidrojen klorür
Yeşil	K	Amonyak
Kırmızı	HG	Cıva buharı
Siyah	CO	Karbonmonoksit
Mavi	NO	Nitrojenmonoksit dahil nitroz gazları
Beyaz	P	Partiküller





## Yarım Yüz Maskeler Half Face Masks

190 gr



elipse

### ELIPSE P3 YARIM YÜZ MASKE

Order Nr.  
Sipariş Kodu  
44501

**Açıklama :** Esnek ve hafif tasarımı ile aynı anda göz koruyucu ile çalışma imkanı sağlayan yarım yüzü koruyan solunum maskesi  
**Description :** Compact, lightweight and flexible design which adapts perfectly to the face and offers a full range of vision without interfering with other eye or ear protections which users choose to wear

**Malzeme / Material :** Termoplastik / Thermoplastic

**Filtre sayısı / Filter :** 2

**Akıllı ventil sayısı / Exhaust valve :** 1

**Ayarlanabilir bant**  
**Adjustable head band :** ✓

**Filtre tipi / Filter :** P3 (44501) / P3 Odour (44502)

**Standart / Certification :** EN 140, EN143



10

elipse

### ELIPSE YARIM YÜZ MASKE SETLERİ



10

44503 ELIPSE A1 YARIM YÜZ MASKE



44488 ELIPSE ABEK1 YARIM YÜZ MASKE



44491 ELIPSE ABEK1-P3 YARIM YÜZ MASKE



**Malzeme / Material :** Termoplastik / Thermoplastic

**Filtre sayısı / Filter :** 2

**Akıllı ventil sayısı / Exhaust valve :** 1

**Ayarlanabilir bant**  
**Adjustable head band :** ✓

**Standart / Certification :** EN 140, EN143

Kullanıma Hazır  
Ready to Use



## Tam Yüz Maskeler Full Face Masks



sorbent®

Order Nr.  
Sipariş Kodu  
809502

### MAG-2 PANORAMİK TAM YÜZ MASKESİ

Açıklama : Yüksek güvenlik ve geniş görüş açısı sunan tam yüz maskesi

Description : The right solution for environments where not only increased respiratory protection is required, but also a clear vision is mandatory



Malzeme / Material : Kauçuk / Rubber

Filtre sayısı / Filter : 2

Akıllı ventil sayısı / Exhaust valve : 2

Filtre bağlantısı / Filter connection : UNIX

Buğulanmaz / Anti-Fog : ❌

Ayarlanabilir bant / Adjustable head band : ✔️

Standart / Certification : EN 136

80975

### KORUYUCU FİLM



### RD 40 FİLTRELER / RD 40 FILTERS

Uyumlu maskeler / Designed for : SR200, MAG

Standart/ Certification : EN 148



\* Filtre sınıfına göre dış gövde plastik veya metal olarak değişiklik gösterebilir  
\* Filter body can be pvc or metal depending on your filter type

6738855 A2 FİLTRE

6732974 P3 FİLTRE

6738779 A2B2 FİLTRE

6738783 A2B2-P3 FİLTRE

6738856 K2 FİLTRE

6738862 AX-P3 FİLTRE

6738863 AX FİLTRE

6738803 A2B2E2K1-P2 FİLTRE

6738802 A2B2EK1 FİLTRE

6738797 A2B2E2K2-HG P3 FİLTRE

6738804 A2B2E2K2 FİLTRE

6738801 A1B2E2K1-HG CO NO P3 FİLTRE



## Tam Yüz Maskeler Full Face Masks

Sundström

Order Nr.  
Sipariş Kodu  
73920

### SUNDSTRÖM SR 200 TAM YÜZ MASKE



EN 136 (CLASS 3)



**Açıklama :** Maksimum güvenlik ve konforlu bir çalışma ortamı için en ideal çözüm. SR200 maske tüm filtre seçenekleri ile birlikte kullanılabilir iken ayrıca tüm motorlu solunum üniteleri ile birlikte de kullanılabilir

**Description :** Intended for use when maximum safety and good breathing comfort are required. The mask can be used either as a filtering device in combination with filters from the Sundström range of filters, or as breathing apparatus with a continuous air flow

**Malzeme / Material :** Silikon / Silicone

**Filtre sayısı / Filter :** 1

**Akıllı ventil sayısı / Exhaust valve :** 2

**Filtre bağlantısı / Filter connection :** EN 148 (RD 40)

**Buğulanmaz / Anti-Fog :** ✓

**Ayarlanabilir bant / Adjustable head band :** ✓

**Standart / Certification :** EN 136



sorbent

Order Nr.  
Sipariş Kodu  
809403

### MAG PANORAMİK TAM YÜZ MASKESİ

**Açıklama :** Geniş görüş açısına sahip tam yüz maskesi

**Description :** Full face mask with a wide field of vision

**Malzeme / Material :** Kauçuk / Rubber

**Filtre sayısı / Filter :** 1

**Akıllı ventil sayısı / Exhaust valve :** 2

**Filtre bağlantısı / Filter connection :** EN 148 (RD 40)

**Buğulanmaz / Anti-Fog :** ✗

**Ayarlanabilir bant / Adjustable head band :** ✓

**Standart / Certification :** EN 136



80975 KORUYUCU FİLM





## Solunum Setleri *Self-Contained Breathing Apparatus*

Order Nr.  
Sipariş Kodu  
**34010**



### DRAGER PASS LITE SET

Açıklama : Oksijenin yetersiz olduğu ortamlar için oksijen tüplü solunum seti

Description : For use in industrial applications where a simple, robust and easy to use breathing apparatus is required

Silindir / Cylinder : Çelik / Steel

Kapasite / Capacity : 6 lt. / 300 bar

Standart / Certification : EN 137 (Type 2)



### DRAGER PSS 3000 SET

Açıklama : Özellikle itfaiye ekipleri için tasarlanmış oksijenin yetersiz olduğu ortamlar için oksijen tüplü solunum seti

Description : High performing breathing apparatus for firefighters. Combining comfort with exceptional pneumatic performance, it is designed for applications where simplicity and ease of use are key essentials

Silindir / Cylinder : Kompozit / Composite

Kapasite / Capacity : 6,8 lt. / 300 bar

Standart / Certification : EN 137 (Type 2)

Order Nr.  
Sipariş Kodu  
**34910**



## Kaçış Maskeleri *Escape Hoods*



Sundström

### SUNDSTRÖM SR 77 KAÇIŞ MASKESİ

Order Nr.  
Sipariş Kodu  
**73930**

Açıklama : Zehirli duman ve gazlardan koruyucu, tek kullanımlık kaçış başlığı  
Description : The escape hood is a filtering respiratory protective device for self-rescue in the event of fire and/or chemical emission accident



Kaçış süresi / Escape duration : 30 Dk / 30 Mins

Ağırlık / Weight : 700 gr

Raf ömrü / Shelf life : 10 Yıl / 10 Years

Standart / Certification : EN 403:2004 M/S,  
EN 14387:2004 + A1:2008



Kişiyeye Özel Taşıma Çantası  
Personal Carry Bag



**30 min**

sorbent®

Order Nr.  
Sipariş Kodu  
**80974**

### ZEVS KAÇIŞ MASKESİ

Açıklama : Zehirli duman ve gazlardan koruyucu, tek kullanımlık kaçış başlığı  
Description : The escape hood is a filtering respiratory protective device for self-rescue in the event of fire and/or chemical emission accident

Kaçış süresi / Escape duration : 15 Dk / 15 Mins

Raf ömrü / Shelf life : 5 Yıl / 5 Years

Standart / Certification : EN 403:2004



Kişiyeye Özel Taşıma Çantası  
Personal Carry Bag





## Motorlu Solunum Üniteleri *Fan Units*



Order Nr.  
Sipariş Kodu  
**73931**

### SUNDSTRÖM SR 500

Açıklama : Farklı filtre seçenekleri ile kullanılabilen, şarj edilebilen motorlu solunum ünitesi

Description : Battery powered fan unit that, together with filters and an approved human interface

Şarj süresi / Charging time : 90 dk / 90 min

Batarya süresi / Operating time : Maks. 13 saat / Max. 13 hours

Standart / Certification : EN 12941, EN 12942



Order Nr.  
Sipariş Kodu  
**73941**



Sundström



### SUNDSTRÖM SR 700

Order Nr.  
Sipariş Kodu  
**73940**



Açıklama : Yoğun toz ortamında çalışma imkanı sunan, şarj edilebilen motorlu solunum ünitesi

Description : Compact and lightweight particle-filter fan unit specially developed for work with harmful and hazardous particles in applications requiring very good protection capability

Şarj süresi 90 dk

Charging time : 90 min

Batarya süresi Maks. 13 saat

Operating time : Max. 13 hours

Standart

Certification : EN 12941, EN 12942





## Unite Başlıkları *Face Pieces*



Sundström

### SUNDSTRÖM SR 520

Order Nr.  
Sipariş Kodu  
73932

Açıklama : Tam koruyucu, oldukça hafif başlık  
Description : Lightweight hood which covers the face and head



Uyumlu üniteler / Suitable for : SR 500, SR 700, SR 99

Ağırlık / Weight : 360 gr

Standart / Certification : EN 12941



Sundström

Order Nr.  
Sipariş Kodu  
73936

### SUNDSTRÖM SR 590



Açıklama : Otomatik kararan ekran ile üniteye uyumlu kaynak başlığı

Description : Protects against inhalation of harmful and irritating air contaminants as well as against radiation and splashes, for instance, when arc welding, MIG, MAG, and TIG welding, and plasma cutting

Uyumlu üniteler / Suitable for : SR 500, SR 700, SR 99

Ağırlık / Weight : 800 gr

Standart / Certification : EN 12941

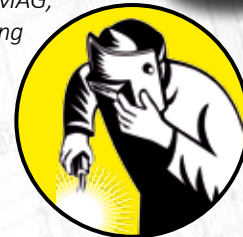

## Unite Başlıkları *Face Pieces*



### SUNDSTRÖM SR 540

**Açıklama :** Açılır/kapanır vizör ünitesi  
**Description :** The visor can be easily flipped up to a good balanced "over the head" position

Uyumlu üniteler / Suitable for : SR 500, SR 700, SR 99

Ağırlık / Weight : 700 gr

Standart / Certification : EN 12941



Order Nr.  
Sipariş Kodu  
**73942**



Order Nr.  
Sipariş Kodu  
**73933**



### SUNDSTRÖM SR 580

**Açıklama :** Gürültü önleyici kulaklık takılabilir, açılır/kapanır vizör ünitesi  
**Description :** Provides complete protection when respiration, face and head protection is required and can be easily combined with the majority of ear defenders

Uyumlu üniteler / Suitable for : SR 500, SR 700, SR 99

Ağırlık / Weight : 875 gr

Standart / Certification : EN 12941

Sundström



Order Nr.  
Sipariş Kodu  
**73934**

Order Nr.  
Sipariş Kodu  
**73943**

**SR 710 P3 FİLTRE**



Uyumlu üniteler SR 500  
Suitable for : SR 700

**SR 599 A1BE2K1-HG P3**



Uyumlu üniteler SR 500  
Suitable for : SR 500



Order Nr.  
Sipariş Kodu  
**73935**





## Hava Beslemeli Sistemler *Supplied Air Respirators*

Sundström

Order Nr.  
Sipariş Kodu  
73944

### SUNDSTRÖM SR 99 HAVA FİLTRESİ

Açıklama : Sürekli hava desteği sağlayan kompresör havasını, solunuma uygun düzeyde temizler

Description : Compressed air filter is used for producing clean breathing air from ordinary compressed air

Kapasite / Capacity: Maks. 900 lt/dk / Max. 900 lt/min

Kullanıcı / User : Maks. 3 kişi / Max. 3 users



### SUNDSTRÖM SR 99H HAVA ISITICI

Açıklama : SR99 filtre ile temizlenen havayı solunuma uygun sıcaklığa yükseltir

Description : Electrical heater unit that warms up the breathable air

Kapasite / Capacity: 80°C

Sundström

Order Nr.  
Sipariş Kodu  
73945



### SR 359 HORTUM

73946



5 - 30 mt

### SR 358 HORTUM

73947



5 - 30 mt

### SR 360 HORTUM

73948



2 - 8 mt

Hava Beslemeli Sistemler *Supplied Air Respirators*



SR 307

73949



SR 507

73950



Sundström

Order Nr.  
Sipariş Kodu  
73951

SUNDSTRÖM SR 63



Açıklama : Sürekli hava destekli sistemler ile kullanılabilir  
PVC başlık

Description : Compressed air hood is a breathing apparatus  
designed for continuous air flow, for connection  
to a compressed air supply



Uyumlu üniteler / Suitable for : SR 99

Ağırlık / Weight : 770 gr

Standart / Certification : EN 14594:2005, 3A3B







# **EL KORUYUCULAR**

## **HAND PROTECTION**

➤ Genel Koruma Eldivenleri  
*General Handling*

➤ Titreşim Eldivenleri  
*Vibration Gloves*

➤ Kesilmeye Dirençli Eldivenler  
*Cut Resistant Gloves*

➤ Isı & Kaynak Eldivenleri  
*Heat Protection & Welding Gloves*

➤ Soğuk Ortam Eldivenleri  
*Cold Insulation Gloves*

➤ Tek Kullanımlık Eldivenler  
*Disposable Gloves*

➤ Kimyasal Koruma Eldivenleri  
*Chemical Resistant Gloves*

## Genel Koruma Eldivenleri *General Handling*

**ARAN**  
SAFETY

Order Nr.  
Sipariş Kodu  
011202

### ARAN SAFETY E10 ECOWORK



4121



Kaplama : ½ Nitril  
Coating : ½ Nitrile

Uzunluk / Length : 220 mm - 270 mm

Bedenler / Sizes : **9** **10**

Standart / Certification : CE EN 388



4121

**ARAN**  
SAFETY

Order Nr.  
Sipariş Kodu  
388823

### ARAN SAFETY E17 URBANE

Kaplama : ½ Nitril  
Coating : ½ Nitrile

Uzunluk / Length : 220 mm - 270 mm

Bedenler / Sizes : **9** **10**

Standart / Certification : CE EN 388



**ARAN**  
SAFETY

Order Nr.  
Sipariş Kodu  
388854

### ARAN SAFETY E19 RETENTIVE



2131



Kaplama : ½ Lateks  
Coating : ½ Latex

Uzunluk / Length : 220 mm - 270 mm

Bedenler / Sizes : **9** **10**

Standart / Certification : CE EN 388





## Genel Koruma Eldivenleri *General Handling*



2131

GUIDE®

### GUIDE 159 LATEKS ELDİVEN

Order Nr.  
Sipariş Kodu  
61490



Kaplama : Polyester, ½ Lateks

Coating : Polyester, ½ Latex

Uzunluk / Length : 230 mm - 290 mm

Bedenler

Sizes : **6** **7** **8** **9** **10** **11**

Standart

Certification : CE EN 388



Kaydırmaz Kaplama  
Reinforced Grip Pattern

GUIDE®

Order Nr.  
Sipariş Kodu  
58590

### GUIDE 585 TAM KAPLI LATEKS ELDİVEN

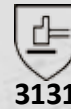

3131

Kaplama/ Coating : Lateks / Latex

Uzunluk / Length : 230 mm - 290 mm

Bedenler / Sizes : **7** **8** **9** **10** **11**

Standart / Certification : CE EN 388



Genel Koruma Eldivenleri *General Handling*



**ARAN SAFETY SWIFT**

4131X **ARAN** SAFETY

240

Kaplama : ½ Poliüretan  
Coating : ½ Polyurethane  
Uzunluk / Length : 220 mm - 270 mm  
Bedenler / Sizes : 7 8 9 10  
Standart / Certification : CE EN 388

**Siyah**  
**Black**  
Order Nr.  
Sipariş Kodu  
388830  
E14

**Beyaz**  
**White**  
Order Nr.  
Sipariş Kodu  
116006  
E24



**GUIDE**

REACH COMPLIANCE

3120

Order Nr.  
Sipariş Kodu  
65090

**GUIDE 650 ULTRA İNCE**

Kaplama : Nyalon, ½ Poliüretan  
Coating : Nylon, ½ Polyurethane  
Uzunluk / Length : 220 mm - 270 mm  
Bedenler / Sizes : 6 7 8 9 10 11  
Standart / Certification : CE EN 388

120

**IS KORUMA** 75



## Genel Koruma Eldivenleri *General Handling*



■ TEGERA®

### TEGERA 414 SENTETİK DERİ EL DİVEN

Order Nr.  
Sipariş Kodu  
41490

Malzeme : Sentetik deri  
Material : Synthetic leather

Uzunluk / Length : 250 mm - 270 mm

Bedenler / Sizes : 8 9 10 11

Standart / Certification : CE EN 388



ARAN  
E11 VERDE

Order Nr.  
Sipariş Kodu  
399409

### ARAN SAFETY E11 VERDE



Kaplama : Parmak ucu poliüretan  
Coating : Polyurethane on fingertips

Uzunluk / Length : 220 mm - 270 mm

Bedenler / Sizes : 7 8 9 10

Standart / Certification : CE EN 388



Parmak Ucu Kaplama  
Fingertips Coating



Genel Koruma Eldivenleri *General Handling*

■ TEGERA®

Order Nr.  
Sipariş Kodu  
09101

TEGERA 9101 ANTI-STATİK ELDİVEN



Malzeme : Sentetik deri  
Material : Synthetic leather

Uzunluk / Length : 216 mm - 253 mm

Bedenler / Sizes : **6** **7** **8** **9** **10**

Standart / Certification : CE EN 388



GUIDE®

GUIDE 414 ANTI-STATIC ELDİVEN

Order Nr.  
Sipariş Kodu  
81190

Kaplama : Nyalon / Karbonfiber, ½ poliüretan  
Coating : Nylon / Carbonfibre, ½ polyurethane

Uzunluk / Length : 220 mm - 270 mm

Bedenler / Sizes : **6** **7** **8** **9** **10**

Standart  
Certification : CE EN 388, EN61340





## Genel Koruma Eldivenleri *General Handling*

**ARAN**  
SAFETY

Order Nr.  
Sipariş Kodu  
**389103**

### ARAN SAFETY E20 COMFORT



3131

Kaplama / Coating : ½ Köpük nitril / ½ Nitrile foam

Uzunluk / Length : 220 mm - 260 mm

Bedenler / Sizes : **8** **9** **10**

Standart / Certification : CE EN 388

240



4131X

**GUIDE**

Order Nr.  
Sipariş Kodu  
**72890**

### GUIDE 577 KÖPÜK NİTRİL EL DİVEN

Kaplama : Nylon, ½ Köpük nitril

Coating : Nylon, ½ Microporous nitrile

Uzunluk / Length : 220 mm - 260 mm

Bedenler

Sizes : **6** **7** **8** **9** **10** **11** **12**

Standart

Certification : CE EN 388

120



## Genel Koruma Eldivenleri *General Handling*

Order Nr.  
Sipariş Kodu  
399102

240

**ARAN**  
SAFETY

### ARAN SAFETY E22 TOTAL



3131

Kaplama / Coating : 3/4 Köpük nitril / 3/4 Nitrile foam

Uzunluk / Length : 220 mm - 260 mm

Bedenler / Sizes : 8 9 10

Standart / Certification : CE EN 388



2131

**ARAN**  
SAFETY

### ARAN SAFETY E30 MAYBARA

Order Nr.  
Sipariş Kodu  
399508

240

Kaplama / Coating : ½ Köpük lateks / ½ Foam latex

Uzunluk / Length : 220 mm - 260 mm

Bedenler / Sizes : 9 10

Standart / Certification : CE EN 388



Order Nr.  
Sipariş Kodu  
399133

240

**ARAN**  
SAFETY

### ARAN SAFETY E12 TIGAR



4132X

Kaplama / Coating : ½ Köpük nitril / ½ Nitrile foam

Uzunluk / Length : 220 mm - 260 mm

Bedenler / Sizes : 7 8 9 10

Standart / Certification : CE EN 388





## Genel Koruma Eldivenleri *General Handling*

**GUIDE**

Order Nr.  
Sipariş Kodu  
**88309**

### GUIDE 580 KÖPÜK NİTRİL ELDİVEN

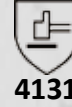

4131



Kaplama : Nylon, ½ Köpük nitril  
Coating : Nylon, ½ Microporous nitrile

Uzunluk / Length : 220 mm - 260 mm

Bedenler / Sizes : **6** **7** **8** **9** **10** **11** **12**

Standart / Certification : CE EN 388



4141

**GUIDE**

Order Nr.  
Sipariş Kodu  
**88490**

### GUIDE 582 NOKTALI ELDİVEN

Kaplama : Nylon, ½ Köpük nitril  
Coating : Nylon, ½ Microporous nitrile

Uzunluk / Length : 220 mm - 260 mm

Bedenler / Sizes : **6** **7** **8** **9** **10** **11**

Standart / Certification : CE EN 388



**Kayırmaz Noktalar**  
Anti-Grip Dots

Genel Koruma Eldivenleri *General Handling*



GUIDE

GUIDE 653 TAM KAPLI ELDİVEN

Order Nr.  
Sipariş Kodu  
88290



Kaplama : Nylon / Likra, Poliüretan / Nitril  
Coating : Nylon / Lycra, Polyurethane / Nitrile  
Uzunluk / Length : 220 mm - 260 mm

Bedenler

Sizes :



Standart

Certification : CE EN 388



GUIDE

Order Nr.  
Sipariş Kodu  
73790

GUIDE 596 TAM KAPLI ELDİVEN

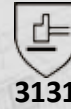

Kaplama : Nylon, Köpük nitril  
Coating : Nylon, Microporous nitrile

Uzunluk / Length : 220 mm - 260 mm

Bedenler / Sizes :



Standart / Certification : CE EN 388

120





## Genel Koruma Eldivenleri *General Handling*

**GUIDE**

Order Nr.  
Sipariş Kodu  
72290

### GUIDE 807 NİTRİL ELDİVEN

Kaplama : Pamuk, 3/4 Nitril  
Coating : Cotton, 3/4 Nitrile

Uzunluk / Length : 220 mm - 270 mm

Bedenler / Sizes : **7** **8** **9** **10**

Standart / Certification : CE EN 388

120



2111



**ARAN**  
SAFETY



4111

### ARAN SAFETY E75 PRO-NITRİL

Kaplama / Coating : 3/4 Nitril / 3/4 Nitrile

Uzunluk / Length : 220 mm - 260 mm

Bedenler / Sizes : **8** **9** **10**

Standart / Certification : CE EN 388

Order Nr.  
Sipariş Kodu  
904207

240



Genel Koruma Eldivenleri *General Handling*



GUIDE®

GUIDE 805 TAM KAPLI ELDİVEN

Order Nr.  
Sipariş Kodu  
74710



Kaplama : Pamuk, Nitril  
Coating : Cotton, Nitrile  
Uzunluk / Length : 220 mm - 270 mm

Bedenler  
Sizes : **10**

Standart  
Certification : CE EN 388



ARAN  
SAFETY

Order Nr.  
Sipariş Kodu  
904184

ARAN SAFETY E70 RICH



Kaplama : Pamuk, Nitril  
Coating : Cotton, Nitrile

Uzunluk / Length : 240 mm - 270 mm

Bedenler / Sizes : **10**

Standart / Certification : CE EN 388

120





## Genel Koruma Eldivenleri *General Handling*



X1XXXX 4121

**TEGERA®**  
INFINITY™

### TEGERA 8800 INFINITY SERİSİ

Order Nr.  
Sipariş Kodu  
88009



Kaplama : Naylon, Köpük nitril

Coating : Nylon, Nitrile foam

Bedenler / Sizes : **6** **7** **8** **9** **10** **11**

Standart

Certification : CE EN 388, EN 407



**TEGERA®**  
INFINITY™

Order Nr.  
Sipariş Kodu  
88029

### TEGERA 8802 INFINITY SERİSİ



4121



X1XXXX



Kaplama : Naylon, Köpük nitril

Coating : Nylon, Nitrile foam

Bedenler / Sizes : **6** **7** **8** **9** **10** **11**

Standart

Certification : CE EN 388, EN 407



Genel Koruma Eldivenleri *General Handling*

■ **TEGERA**<sup>®</sup>  
INFINITY™

Order Nr.  
Sipariş Kodu  
88039

**TEGERA 8803 INFINITY SERİSİ**

Kaplama : Naylon, 3/4 Köpük nitril  
Coating : Nylon, 3/4 Nitrile foam

Bedenler / Sizes : **7** **8** **9** **10** **11**

Standart

Certification : CE EN 388, EN 407

120

40



4121



X1XXXX



■ **TEGERA**<sup>®</sup>  
INFINITY™

Order Nr.  
Sipariş Kodu  
88049

**TEGERA 8804 INFINITY SERİSİ**

Kaplama : Naylon, Köpük nitril  
Coating : Nylon, Nitrile foam

Bedenler / Sizes : **7** **8** **9** **10** **11**

Standart

Certification : CE EN 388, EN 407, EN 511

120

40



XX1



X1XXXX



4121





## Genel Koruma Eldivenleri *General Handling*

Order Nr.  
Sipariş Kodu  
440058

### KAPLAMASIZ ÖRME ELDİVEN



X11X



Malzeme : Pamuk  
Material : Cotton

Uzunluk / Length : 220 mm - 260 mm

Bedenler / Sizes : **10**

Standart / Certification : CE EN 388 (CAT I)

Order Nr.  
Sipariş Kodu  
115009

### PVC NOKTALI ELDİVEN



X11X



Malzeme : Pamuk & PVC noktalar  
Material : Cotton & PVC dots

Uzunluk / Length : 220 mm - 260 mm

Bedenler / Sizes : **10**

Standart / Certification : CE EN 388 (CAT I)



Çift-Tarafli  
Reversible



## EN 388:2016 PERFORMANS DEĞERLERİ / EN 388:2016 LEVEL OF PROTECTION



ABCDEF

### Özellik / Property

### Maks. Performans Max. Performance

A) Aşınma Direnci / Resistance To Wear	4
B) Kesilme Direnci / Cut Resistance	5
C) Yırtılma Direnci / Tear Resistance	4
D) Delinme Direnci / Puncturing Resistance	4
E) Kesilme Direnci / Cut Resistance (EN ISO 13997)	F
F) Darbe Direnci / Impact Protection (EN 13594:2015)	P

Genel Koruma Eldivenleri *General Handling*



■ TEGERA®

**TEGERA 52 DERİ ELDİVEN**

Order Nr.  
Sipariş Kodu  
52100

Malzeme / Material : Deri / Leather

Kalınlık / Thickness : 0,7 mm - 0,8 mm

Uzunluk / Length : 220 mm - 250 mm

Bedenler / Sizes : 7 8 9 10 11

Standart / Certification : CE EN 388



■ TEGERA®

Order Nr.  
Sipariş Kodu  
32110

**TEGERA 321 SENTETİK DERİ ELDİVEN**

Malzeme / Material : Sentetik deri / Synthetic leather

Kalınlık / Thickness : 0,6 mm

Uzunluk / Length : 220 mm - 260 mm

Bedenler / Sizes : 6 7 8 9 10 11

Standart / Certification : CE EN 388





## Genel Koruma Eldivenleri *General Handling*

Order Nr.  
Sipariş Kodu  
32010

■ TEGERA®

### TEGERA 320 SENTETİK DERİ ELDİVEN

Malzeme / Material : Sentetik deri / Synthetic leather

Kalınlık / Thickness : 0,6 mm

Uzunluk / Length : 223 mm - 248 mm

Bedenler / Sizes : 7 8 9 10 11

Standart / Certification : CE EN 388



2021



2000

■ TEGERA®

### TEGERA 13 DERİ ELDİVEN

Malzeme / Material : Deri / Leather

Kalınlık / Thickness : 0,7 mm - 0,8 mm

Uzunluk / Length : 235 mm - 270 mm

Bedenler / Sizes : 7 8 9 10 11

Standart / Certification : CE EN 388

Order Nr.  
Sipariş Kodu  
12013



Cırtlı-Bilek  
Velcro

## Genel Koruma Eldivenleri *General Handling*



■ **TEGERA®**

Order Nr.  
Sipariş Kodu  
**11490**

### TEGERA 114 DERİ ELDİVEN



Malzeme / Material : Deri / Leather

Kalınlık / Thickness : 0,6 mm - 0,7 mm

Uzunluk / Length : 210 mm - 260 mm

Bedenler / Sizes : 5 6 7 8 9 10 11

Standart / Certification : CE EN 388



Order Nr.  
Sipariş Kodu  
**64010**

■ **TEGERA®**

### TEGERA 640 DERİ ELDİVEN

Malzeme / Material : Deri / Leather

Kalınlık / Thickness : 0,7 mm - 0,8 mm

Uzunluk / Length : 230 mm - 260 mm

Bedenler / Sizes : 7 8 9 10 11

Standart / Certification : CE EN 388



2122





## Genel Koruma Eldivenleri *General Handling*



### DERİ TAKVİYELİ AĞIR İŞ ELDİVENİ

Order Nr.  
Sipariş Kodu  
112015



Malzeme / Material : Deri / Leather

Uzunluk / Length : 240 mm - 270 mm

Bedenler / Sizes : **10**

Standart / Certification : CE EN 388

120

### TEGERA®

Order Nr.  
Sipariş Kodu  
35100

### TEGERA 35 DERİ ELDİVEN



Malzeme / Material : Deri / Leather

Kalınlık / Thickness : 1,2 mm - 1,4 mm

Uzunluk / Length : 240 mm - 270 mm

Bedenler / Sizes : **8** **9** **10** **11**

Standart / Certification : CE EN 388

60



Genel Koruma Eldivenleri *General Handling*

■ TEGERA®

Order Nr.  
Sipariş Kodu  
09120

TEGERA 9120 SENTETİK DERİ ELDİVEN



Malzeme / Material : Sentetik deri / Synthetic leather

Kalınlık / Thickness : 0,7 mm

Uzunluk / Length : 198 mm - 243 mm

Bedenler / Sizes : 6 7 8 9 10 11

Standart / Certification : CE EN 388

60



Cırtlı Bilek  
Velcro



■ TEGERA®

TEGERA 9124 MICROTHAN ELDİVEN

Order Nr.  
Sipariş Kodu  
912409

Malzeme / Material : Sentetik deri / Synthetic leather

Kalınlık / Thickness : 0,7 mm

Uzunluk / Length : 195 mm - 235 mm

Bedenler / Sizes : 7 8 9 10 11 12 13

Standart / Certification : CE EN 388

60





## Genel Koruma Eldivenleri *General Handling*



4121

■ TEGERA®

### TEGERA 901 DERİ ELDİVEN

Order Nr.  
Sipariş Kodu  
90110



Malzeme / Material : Deri eldiven / Leather

Kalınlık / Thickness : 0,6 mm - 0,7 mm

Uzunluk / Length : 250 mm

Bedenler / Sizes :

7 8 9 10 11 12 13

Standart / Certification : CE EN 388



■ TEGERA®

Order Nr.  
Sipariş Kodu  
92059

### TEGERA 9205 MACROTHAN ELDİVEN

Malzeme / Material : Sentetik deri / Synthetic leather

Kalınlık / Thickness : 0,8 mm

Uzunluk / Length : 200 mm - 240 mm

Bedenler / Sizes :

7 8 9 10 11

Standart / Certification : CE EN 388



2242



## Titreşim Eldivenleri *Vibration Gloves*

Order Nr.  
Sipariş Kodu  
010100

### ŞOK EMİCİ DARBE ELDİVENİ

4121

Malzeme / Material : Polyester, Köpük nitril  
Polyester, Nitrile foam

Uzunluk / Length : 210 mm - 250 mm

Bedenler / Sizes : 8 9 10 11

Standart / Certification : CE EN 388

72



PVC Bariyerler  
PVC Barriers



TEGERA®

### TEGERA 9180 VİBRASYON ELDİVENİ

Order Nr.  
Sipariş Kodu  
918009

Malzeme / Material : Sentetik deri / Synthetic leather

Uzunluk / Length : 210 mm - 242 mm

Bedenler / Sizes : 7 8 9 10 11 12

Standart / Certification : CE EN 388, EN ISO 10819

0222



60





## Kesilmeye Dirençli Eldivenler *Cut Resistant Gloves*



4342

GUIDE®

### GUIDE 315 KESİLMEME DİRENÇLİ ELDİVEN

Order Nr.  
Sipariş Kodu  
31590

Kaplama / Coating : ½ Nitril, ½ Nitrile

Uzunluk / Length : 220 mm - 270 mm

Bedenler / Sizes : 7 8 9 10 11 12

Standart

Certification : CE EN 388



GUIDE®

Order Nr.  
Sipariş Kodu  
43090

### GUIDE 308 KESİLMEME DİRENÇLİ ELDİVEN



4342



Kaplama ½ Poliüretan

Coating : ½ Polyurethane

Uzunluk / Length : 220 mm - 270 mm

Bedenler / Sizes : 6 7 8 9 10 11

Standart / Certification : CE EN 388



Kesilmeye Dirençli Eldivenler *Cut Resistant Gloves*

GUIDE

Order Nr.  
Sipariş Kodu  
30190

GUIDE 301 KESİLMEME DİRENÇLİ EL DİVEN



4432



Kaplama ½ Poliüretan / Nitril  
Coating : ½ Polyurethane / Nitrile

Uzunluk / Length : 220 mm - 270 mm

Bedenler / Sizes : 6 7 8 9 10 11

Standart / Certification : CE EN 388

120



3444

GUIDE

GUIDE 295 KESİLMEME DİRENÇLİ EL DİVEN

Order Nr.  
Sipariş Kodu  
29510

Kaplama / Coating : Kevlar, ½ Lateks  
Kevlar, ½ Latex

Uzunluk / Length : 220 mm - 270 mm

Bedenler / Sizes : 7 8 9 10 11

Standart

Certification : CE EN 388

72





## Kesilmeye Dirençli Eldivenler *Cut Resistant Gloves*

**ARAN**  
SAFETY

Order Nr.  
Sipariş Kodu  
**388878**

### ARAN SAFETY E90 HARD-CUT

Malzeme / Material : ½ Poliüretan / ½ Polyurethane

Uzunluk / Length : 220 mm - 270 mm

Bedenler / Sizes : **8** **9** **10**

Standart / Certification : CE EN 388



4X43D

**CUT5**



4343

### ARAN SAFETY E80 SAFE-CUT

Malzeme / Material : ½ Poliüretan / ½ Polyurethane

Uzunluk / Length : 220 mm - 270 mm

Bedenler / Sizes : **8** **9** **10**

Standart / Certification : CE EN 388

**ARAN**  
SAFETY

Order Nr.  
Sipariş Kodu  
**388885**

120



Kesilmeye Dirençli Eldivenler *Cut Resistant Gloves*

CUT5



GUIDE 314 KESİLMEME DİRENÇLİ ELDİVEN

Order Nr.  
Sipariş Kodu  
31490



Kaplama ½ Poliüretan  
Coating : ½ Polyurethane  
Uzunluk / Length : 220 mm - 270 mm  
Bedenler / Sizes : 7 8 9 10 11 12  
Standart  
Certification : CE EN 388

120

GUIDE

Order Nr.  
Sipariş Kodu  
45090

GUIDE 384 KESİLMEME DİRENÇLİ ELDİVEN



CUT5

Kaplama / Coating : ½ Nitril, ½ Nitrile  
Uzunluk / Length : 220 mm - 270 mm  
Bedenler / Sizes : 7 8 9 10 11  
Standart / Certification : CE EN 388

120

Order Nr.  
Sipariş Kodu  
38690

GUIDE 386





## Kesilmeye Dirençli Eldivenler *Cut Resistant Gloves*



4X44F

GUIDE

### GUIDE 6330 İĞNE BATMAZ ELDİVEN

Order Nr.  
Sipariş Kodu  
63309

Kaplama 3/4 nitril

Coating : 3/4 nitrile

Uzunluk / Length : 220 mm - 270 mm

Bedenler / Sizes : 8 9 10 11

Standart

Certification : CE EN 388

36



İğne Batmaz  
Needle Protection

TEGERA

Order Nr.  
Sipariş Kodu  
21509

### TEGERA 215 KESİLMEME DİRENÇLİ ELDİVEN



2322



Malzeme / Material : Kevlar, Deri / Kevlar, Leather

Uzunluk / Length : 210 mm - 260 mm

Bedenler / Sizes : 7 8 9 10 11 12

Standart / Certification : CE EN 388

120



## Çelik Örgü Kesilmez Eldivenler *Stainless Steel Gloves*

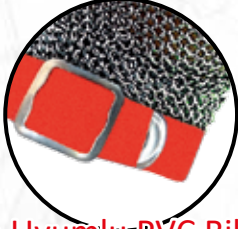

Gıda Uyumlu-PVC Bileklik  
*PVC Wrist Strap*



EN 1082



### CUT-WARDER 5 PARMAK

Malzeme / Material : Paslanmaz çelik / *Stainless steel*

Parmak / Fingers : 3 (01803) / 5 (018102)

Uzunluk / Length : 188 mm - 250 mm

Bedenler / Sizes : **XXS** **XS** **S** **M** **L** **XL**

Standart / Certification : CE EN 1082



Çift Taraflı  
*Reversible*



Order Nr.  
Sipariş Kodu  
**018102**



Order Nr.  
Sipariş Kodu  
**01803**



Order Nr.  
Sipariş Kodu  
**018102-D**

### CUT-WARDER 3 LONG

Malzeme / Material : Paslanmaz çelik / *Stainless steel*

Parmak / Fingers : 5

Uzunluk / Length : 338 mm - 400 mm

Bedenler / Sizes : **XXS** **XS** **S** **M** **L** **XL**

Standart / Certification : CE EN 1082



EN 1082

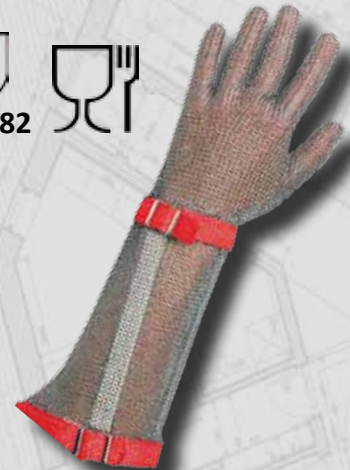



## Isı & Kaynak Eldivenleri Heat & Welding Gloves



250°C

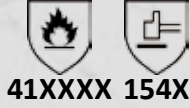

41XXXX 154X

CUT 5

### ISI ELDİVENİ

Order Nr.  
Sipariş Kodu  
01723

Malzeme / Material : Kevlar

Uzunluk / Length : 265 mm - 305 mm

Bedenler / Sizes : 9 10

Standart / Certification : CE EN 388, EN 407

36

Order Nr.  
Sipariş Kodu  
011800

### KOLLUK



454X X1XXXX

Malzeme / Material : Kevlar

Uzunluk / Length : 45 cm

Standart / Certification : CE EN 388, EN 407

60

CUT 5

100°C



### EN 407 PERFORMANS DEĞERLERİ / EN 407 LEVEL OF PROTECTION



A B C D E F

#### Özellik / Property

#### Maks. Performans Max. Performance

A) Yanma Direnci / Burning Behaviour	4
B) Isı İle Temas Direnci / Contact Heat	4
C) Konvektif Isı Direnci / Convective Heat	4
D) Radyant Isı Direnci / Radiant Heat	4
E) Küçük Ergimiş Metallerle Direnç Resistance to Small Metal Splashes	4
F) Büyük Ergimiş Metallerle Direnç Resistance to Molten Metal Splashes	4

Isı & Kaynak Eldivenleri *Heat & Welding Gloves*

Order Nr.  
Sipariş Kodu  
13990

■ TEGERA®

TEGERA 139 KAYNAK ELDİVENİ



4244



41324X



60

Malzeme : Kevlar, Deri  
Material : Kevlar, Leather  
Uzunluk  
Length : 265 mm - 305 mm  
Kalınlık  
Thickness : 0,9 - 1,1 mm

Bedenler

Sizes : **6** **7** **8** **9** **10** **11** **12** **13** **14** **15**

Standart

Certification : CE EN 388, EN 407, EN 1149-2



X2XXXX 3242



■ TEGERA®

TEGERA 464 ISI ELDİVENİ

Order Nr.  
Sipariş Kodu  
46411

Malzeme : Pamuk, Nitril  
Material : Cotton, Nitrile

Uzunluk / Length : 350 mm

Bedenler / Sizes : **9** **10** **11**

Standart / Certification : CE EN 388, EN 407

60





## Isı & Kaynak Eldivenleri Heat & Welding Gloves



412X4X 3121

TEGERA®

### TEGERA 118A ARGON KAYNAK ELDİVENİ

Order Nr.  
Sipariş Kodu  
11810



Malzeme / Material : Deri / Leather

Uzunluk / Length : 310 mm - 360 mm

Kalınlık / Thickness : 0,7 - 0,8 mm

Bedenler / Sizes : 7 8 9 10 11 12

Standart / Certification : CE EN 388, EN 407, EN 12477



TEGERA®

Order Nr.  
Sipariş Kodu  
13010

### TEGERA 130 ARGON KAYNAK ELDİVENİ



3111 412X4X

Malzeme / Material : Deri / Leather

Uzunluk / Length : 300 mm - 350 mm

Kalınlık / Thickness : 0,7 - 0,8 mm

Bedenler / Sizes : 6 7 8 9 10 11

Standart / Certification : CE EN 388, EN 407,  
EN 12477+A1, EN 1149-2



100°C



Isı & Kaynak Eldivenleri *Heat & Welding Gloves*

Order Nr.  
Sipariş Kodu  
32009

60

■ TEGERA®

TEGERA 32 KAYNAK ELDİVENİ

Malzeme / Material : Kevlar, Deri / Kevlar, Leather

Uzunluk / Length : 250 mm - 290 mm

Kalınlık / Thickness : 0,7 - 0,8 mm

Bedenler / Sizes : 7 8 9 10 11 12 13

Standart / Certification : CE EN 388, EN 407



3243



41224X



100°C



41324X



3432

100°C



■ TEGERA®

TEGERA 132 KAYNAK ELDİVENİ

Malzeme / Material : Kevlar, Deri / Kevlar, Leather

Uzunluk / Length : 310 mm - 370 mm

Kalınlık / Thickness : 0,8 - 1,2 mm

Bedenler / Sizes : 7 8 9 10 11 12 13

Standart / Certification : CE EN 388, EN 407,  
EN 12477, EN 1149-2

Order Nr.  
Sipariş Kodu  
13210

60





## Isı & Kaynak Eldivenleri *Heat & Welding Gloves*

Order Nr.  
Sipariş Kodu  
01710

■ TEGERA®

### TEGERA 17 KAYNAK ELDİVENİ

Malzeme / Material : Deri / Leather

Uzunluk / Length : 240 mm - 280 mm

Kalınlık / Thickness : 1,2 - 1,4 mm

Bedenler / Sizes : **8** **10** **11**

Standart / Certification : CE EN 388, EN 407

60



3223



413X4X



4143



41XXXX



### WELDER KAYNAK ELDİVENİ

Malzeme / Material : Deri / Leather

Uzunluk / Length : 350 mm

Bedenler / Sizes : **10**

Standart / Certification : CE EN 388, EN 407

Order Nr.  
Sipariş Kodu  
013312

60

Isı & Kaynak Eldivenleri *Heat & Welding Gloves*



■ TEGERA®

**TEGERA 19 KAYNAK ELDİVENİ**

Order Nr.  
Sipariş Kodu  
**19100**

Malzeme / Material : Deri / Leather

Uzunluk / Length : 310 mm - 360 mm

Kalınlık / Thickness : 1,2 - 1,4 mm

Bedenler / Sizes : **8** **9** **10** **11**

Standart / Certification : CE EN 388, EN 407,  
EN 12477+A1, EN 1149-2

60

**100°C**



**TEGERA 19 KAYNAK ELDİVENİNİ SADECE SOL EL OLARAK SATIN ALABİLİRSİNİZ !**

**YOU CAN PURCHASE AN EXTRA LEFT TEGERA 19 SEPERATELY !**





## Soğuk Ortam Eldivenleri Cold Insulation Gloves



01X 2001

TEGERA®

### TEGERA 117 SOĞUK ORTAM ELDİVENİ

Order Nr.  
Sipariş Kodu  
11790



Malzeme / Material : Deri / Leather

Kalınlık / Thickness : 0,6 mm - 0,7 mm

Uzunluk / Length : 230 mm - 285 mm

Bedenler / Sizes : 6 7 8 9 10 11

Standart / Certification : CE EN 388, EN 511



Cırtlı-Bilek  
Velcro

TEGERA®

Order Nr.  
Sipariş Kodu  
912810

### TEGERA 9128 SOĞUK ORTAM ELDİVENİ



1111

11X



Malzeme / Material : Sentetik deri / Synthetic leather

Kalınlık / Thickness : 0,7 mm

Uzunluk / Length : 240 mm - 275 mm

Bedenler / Sizes : 7 8 9 10 11

Standart / Certification : CE EN 388, EN 511



Dokunmatik Ekran Uyumlu  
Suitable For Touch Screen

Soğuk Ortam Eldivenleri *Cold Insulation Gloves*

GUIDE

Order Nr.  
Sipariş Kodu  
68310

GUIDE 160W SOĞUK ORTAM ELDİVENİ

Kaplama Pamuk, 3/4 Lateks  
Coating : Cotton, 3/4 Latex

Uzunluk / Length : 240 mm - 290 mm

Bedenler / Sizes : 7 8 9 10 11

Standart / Certification : CE EN 388, EN 511

72



TEGERA

Order Nr.  
Sipariş Kodu  
51710

TEGERA 517 SOĞUK ORTAM ELDİVENİ

Malzeme / Material : Sentetik deri / Synthetic leather

Kalınlık / Thickness : 0,7 mm

Uzunluk / Length : 235 mm - 255 mm

Bedenler / Sizes : 8 9 10 11

Standart / Certification : CE EN 388, EN 511



1121



11X



60



EN 511 PERFORMANS DEĞERLERİ / EN 511 LEVEL OF PROTECTION



A B C

Özellik / Property	Maks. Performans Max. Performance
A) Konvektif Soğuk Termal Yalıtım Convective Cold	4
B) Temaslı Soğuk, Termal Direnç Contact Cold	4
C) Su Geçirmezliği Capability of Resisting Water	1



## Soğuk Ortam Eldivenleri Cold Insulation Gloves



12X 2111

TEGERA®

### TEGERA 335 SOĞUK ORTAM ELDİVENİ

Order Nr.  
Sipariş Kodu  
33510



Malzeme / Material : Deri / Leather

Uzunluk / Length : 220 mm - 270 mm

Kalınlık / Thickness : 0,6 - 0,7 mm

Bedenler / Sizes : 7 8 9 10 11

Standart / Certification : CE EN 388, EN 511



Çırtlı Bilek  
Velcro

TEGERA®

Order Nr.  
Sipariş Kodu  
37710

### TEGERA 377 SOĞUK ORTAM ELDİVENİ



3211

12X

Malzeme / Material : Deri / Leather

Uzunluk / Length : 270 mm - 290 mm

Kalınlık / Thickness : 0,7 - 0,8 mm

Bedenler / Sizes : 8 10 11

Standart / Certification : CE EN 388, EN 511



## Tek Kullanımlık Eldivenler *Disposable Gloves*

Order Nr.  
Sipariş Kodu  
84990

**TEGERA®**

### TEGERA 849 TEK KULLANIMLIK ELDİVEN

Malzeme / Material : Nitril / Nitrile

Kalınlık / Thickness : 0,19 mm

Uzunluk / Length : 290 mm

Bedenler / Sizes : **7** **8** **9** **10** **11** **12**

Standart / Certification : CE EN 388, EN 374-2, EN 374-3

10

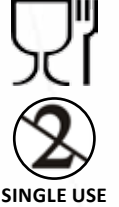

Pudrasız  
Non Powder

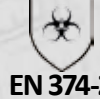

**TEGERA®**

### TEGERA 84501 TEK KULLANIMLIK ELDİVEN

Malzeme / Material : Nitril / Nitrile

Kalınlık / Thickness : 0,10 mm

Uzunluk / Length : 240 mm

Bedenler / Sizes : **7** **8** **9** **10** **11**

Standart / Certification : CE EN 374-2, EN 374-3

Order Nr.  
Sipariş Kodu  
845019

10



Pudrasız  
Non Powder



## Kimyasal Risk Eldivenleri *Chemical Resistant Gloves*



### KİMYASAL KORUNMA KILAVUZU / CHEMICAL PROTECTION GUIDE

Açık yeşil nüfuz etmeye oluşumuna karşı 4 saatten uzun korumayı ve koyu yeşil alanlar nüfuz etmeye karşı 8 saatten uzun korumayı temsil eder. Açık yeşil alanlar 4 saatten sonra geçirgenlik kasıldığında bile yapılan testleri belirtir. Not: Bu tavsiyeler oda sıcaklığında sürekli temasta gerçekleştirilen geçirgenlik testlerinden elde edilen raporlara dayanmaktadır. Daha yüksek sıcaklıklarda nüfuz etme süresi kısalmaktadır.

T = Çok zehirli  
T = Zehirli  
K = Kansere neden olabilir  
M = Genetik hasara neden olabilir  
S = Alerjiye neden olabilir  
R = Öreme yeteneğinde azalmaya neden olabilir

Xn = Zararlı  
Xi = Tahriş edici  
C = Çok aşındırıcı  
C = Aşındırıcı  
F+ = Aşırı yanıcı  
F = Çok yanıcı  
K veya M'den sonra 3 = Kansere neden olma şüphesi

Kimyasal adı (Eşanlam)	Bütül kauçuk	Doğal kauçuk	Neopren kauçuk	Nitril kauçuk	Polietilen, PE	Polivinil alkol PVAl	Polivinil klorür PVC	Vitron®	Tehlike
Asetaldehit									Xn, K3, F+
Aseton									F
Asetonitril									T, F
Akrilamid, %30-70									T, K3, M, R, S
Akrilitril									T, K3, F
Akrilik asit									C
Alil alkol									T
Alilamin									T
Alkil klorür (3-Kloropropan)									T, F
Amonyum florid, %30-70									T, F
Amonyak çözeltisi, %30									C
Anilin									T, C3
Akışık									C
Benzen									T, K3
Petrol, kurgunlaştır									T, K3
Benzol klorür									T, K3
Benzaldehit									Xn, K3, F+
γ-Bromopropiyonik asit									C
Hidrobronsik asit, %30-70									Cx
n-Bütül asetat									
n-Bütanol (Bütül alkol)									Xi
Bütül akrilat									Xi, S
n-Bütylamin									X, C, F
Bütül glisöl (2-Bütoksi etanol)									Xi
Bütül glisöl asetat (2-Bütoksi asetat)									X, C, F
gamma-Butirolaktam									X
Sikloheksan									Xi
Sikloheksanol									Xi
Sikloheksanon									X
Diole									X, K3, F
Dietanilamin									Xi
Dietilamin									C, X, F
Dietildiklorosilan									C, F
Dietilglisöl									Xn
Dietilamin									C, X, S

Kimyasal adı (Eşanlam)	Bütül kauçuk	Doğal kauçuk	Neopren kauçuk	Nitril kauçuk	Polietilen, PE	Polivinil alkol PVAl	Polivinil klorür PVC	Vitron®	Tehlike
Bisfenol A'nin diğlisidli esteri									Xi, S
Dizobutil peroksit									Xi
Dikropropilamin									C, Xi, F
3-Dietylamin) etanol									C, Xi
1,2-Dikloroetilen (1,2-dikloroetilen)									Xi
1,3-Dikloroetilen									Xn, F
N,N-Dimetilasetamid									T, R
N,N-Dimetilamin (DMA)									T, K3
Demetilformamid (DMF)									T
Demetil sülfat									T, X2, M, S, C
Demetilsülfoksit									Xi
Di-n-bütül ftalat (DBP)									T, R
Dioksit ftalat (DOP)									T, R
1,4-Dioksan									Xi, K3, F
Dioksit									T+
Epiklorohidrin									T, K3, S, C
Epoksi bağlayıcıları									Xn, S
Etanol (Etül alkol)									F
Etanolamin									Xi
Etül asetat									Xi, F
Etül akrilat									Xi, S, F
Etülam (monometilamin)									Xi, F+
Etübenzen									Xi, F
Etilendiamin (1,2-diaminoetanol)									Xn, C, S
Etilen diklorit (1,2-dikloroetanol)									T, K3
Etilenglisöl									Xn
Etilen oksit gazı									T, K3, M, F+
Etil ester (Dietyl eter)									Xn, F+
Etil glisöl (2-Etoksi etanol)									T, R
Etil glisöl asetat (2-Etoksi asetat)									T, R
Etilmetakrilat									Xi, S, F
Fenol, >1% 70									T, C
Fluorhidrik asit, % 30-70									T+, Cx
Formaldehit, % 30-70									T, C, S
Formik asit, >1% 70									C

Tavsiyeler (ince < 0,3mm) Doğal Kauçuk, Neopren, Nitril veya PVC eldivenleri için geçerlidir.

■ > 8 saat tavsiye edilir.  
■ > 4 saat tavsiye edilir.  
■ Dikkat! - 4 saat.

■ > 1 saat tavsiye edilmez (bozulma olasıdır).  
□ Test edilmemiştir.

Kimyasal Risk Eldivenleri *Chemical Resistant Gloves*

KİMYASAL KORUNMA KILAVUZU / CHEMICAL PROTECTION GUIDE



Kimyasal adı (İspanca)	Büyük kaşık	Orta kaşık	Küçük kaşık	Nitril kaşık	Poliüretan, PE	Poliüretan ağırlıklı PVAl	Poliüretan ağırlıklı PVC	Vitru®	Yapışık
Fotijen	Red	Red	Red	Red	Red	Red	Red	Red	Xn
Fluor (F2/TF)	Red	Red	Red	Red	Red	Red	Red	Red	T,K
Formal (2-formaldehid)	Red	Red	Red	Red	Red	Red	Red	Red	Xn
Furforal	Red	Red	Red	Red	Red	Red	Red	Red	T,C
Tamir	Red	Red	Red	Red	Red	Red	Red	Red	T,S
Gutanalolit, %50-70	Red	Red	Red	Red	Red	Red	Red	Red	T,S
Hidrojen	Red	Red	Red	Red	Red	Red	Red	Red	T,S
Hidrojenli %5-40% hidrojen	Red	Red	Red	Red	Red	Red	Red	Red	Xn, C, F
Hidrojenli hidrojen	Red	Red	Red	Red	Red	Red	Red	Red	Xn
Hidrojenli yağ	Red	Red	Red	Red	Red	Red	Red	Red	Xn
Hidrojenli	Red	Red	Red	Red	Red	Red	Red	Red	T,C,K
Hidrojenli	Red	Red	Red	Red	Red	Red	Red	Red	X, S, K3, M3
2-Hidrojenli alkol	Red	Red	Red	Red	Red	Red	Red	Red	T,S
2-Hidrojenli metanol (HMA)	Red	Red	Red	Red	Red	Red	Red	Red	Xi, S
İzobutan-2-sitonyat (DI)	Red	Red	Red	Red	Red	Red	Red	Red	T,S
İzobutan (izobütil alkol)	Red	Red	Red	Red	Red	Red	Red	Red	Xi
İzopropil (izopropil alkol)	Red	Red	Red	Red	Red	Red	Red	Red	Xi
Potasyum hidroksit, %50-70	Red	Red	Red	Red	Red	Red	Red	Red	Cx
Kapri asit (Doksan asit)	Red	Red	Red	Red	Red	Red	Red	Red	C
Kloroform	Red	Red	Red	Red	Red	Red	Red	Red	Xn
2-Kloroasetik	Red	Red	Red	Red	Red	Red	Red	Red	T+
Kloroasetik	Red	Red	Red	Red	Red	Red	Red	Red	T
1-Kloroasetik	Red	Red	Red	Red	Red	Red	Red	Red	Xn
Kloroform (Triklorometan)	Red	Red	Red	Red	Red	Red	Red	Red	Xn, K2
Kloroform (2-Kloro-1,1-dikloro)	Red	Red	Red	Red	Red	Red	Red	Red	Xn, F
o-Kloroform (2-Kloroform)	Red	Red	Red	Red	Red	Red	Red	Red	Xn
Kloroasetik asit (Dikloroasetik asit)	Red	Red	Red	Red	Red	Red	Red	Red	T,C
Karbon dioksit	Red	Red	Red	Red	Red	Red	Red	Red	T,R
Karbon tetraklorit	Red	Red	Red	Red	Red	Red	Red	Red	T,K
Krom	Red	Red	Red	Red	Red	Red	Red	Red	T,C
Kromik asit, %30-70	Red	Red	Red	Red	Red	Red	Red	Red	T,Cx, K,S
Kromik asit (Kromik asit)	Red	Red	Red	Red	Red	Red	Red	Red	Xn
Azotlu asit	Red	Red	Red	Red	Red	Red	Red	Red	Cx
Boya asit (Diyoksan asit asit)	Red	Red	Red	Red	Red	Red	Red	Red	Xn
Laurik asit, %30-70	Red	Red	Red	Red	Red	Red	Red	Red	Xi, S
Limonen	Red	Red	Red	Red	Red	Red	Red	Red	Xi, F
Maleik asit	Red	Red	Red	Red	Red	Red	Red	Red	Xi
Markaptoasetik asit (Tiyoglikol asit)	Red	Red	Red	Red	Red	Red	Red	Red	T,C
Metakril asit	Red	Red	Red	Red	Red	Red	Red	Red	Cx, Xn
Metanol (metil alkol)	Red	Red	Red	Red	Red	Red	Red	Red	T
Metil asit	Red	Red	Red	Red	Red	Red	Red	Red	Xi, F
Metilamin, %30-70	Red	Red	Red	Red	Red	Red	Red	Red	Xi, F+
Metilbenzenli-44' (Stilbenzen)	Red	Red	Red	Red	Red	Red	Red	Red	Xi, S
Metilbenzenli-44' (Stilbenzen)	Red	Red	Red	Red	Red	Red	Red	Red	Xn
1,4-metilenbis (MDA)	Red	Red	Red	Red	Red	Red	Red	Red	T, K, S
Metilbenzenli (Stilbenzen)	Red	Red	Red	Red	Red	Red	Red	Red	Xn, K3
Metilbenzen (MEK)	Red	Red	Red	Red	Red	Red	Red	Red	Xi, F
Metil glikol (2-metoksietanol)	Red	Red	Red	Red	Red	Red	Red	Red	T,R
Metil glikol asit (2-Metoksietanol asit)	Red	Red	Red	Red	Red	Red	Red	Red	T,R
Metilbenzenli (MEK)	Red	Red	Red	Red	Red	Red	Red	Red	Xn, F
Metil benzen (yot menen)	Red	Red	Red	Red	Red	Red	Red	Red	T,K

Kimyasal adı (İspanca)	Büyük kaşık	Orta kaşık	Küçük kaşık	Nitril kaşık	Poliüretan, PE	Poliüretan ağırlıklı PVAl	Poliüretan ağırlıklı PVC	Vitru®	Yapışık
Metilmetakrilat	Red	Red	Red	Red	Red	Red	Red	Red	Xi, S
Metil metakrilat (MTBE)	Red	Red	Red	Red	Red	Red	Red	Red	Xi, F
Morfalin	Red	Red	Red	Red	Red	Red	Red	Red	C
Formik asit, %50	Red	Red	Red	Red	Red	Red	Red	Red	Cx
Sodyum hidroksit, 30-70%	Red	Red	Red	Red	Red	Red	Red	Red	Cx
Sodyum hipoklorit, 30-70%	Red	Red	Red	Red	Red	Red	Red	Red	C
Nitrojen	Red	Red	Red	Red	Red	Red	Red	Red	T+
Nitrobenzen	Red	Red	Red	Red	Red	Red	Red	Red	T, K3
Nitrogliserin (Nitrogliserin)	Red	Red	Red	Red	Red	Red	Red	Red	T+
Nitrogliserin	Red	Red	Red	Red	Red	Red	Red	Red	T+
Nitrobenzen	Red	Red	Red	Red	Red	Red	Red	Red	Xn
2-Nitropropan	Red	Red	Red	Red	Red	Red	Red	Red	T, K
2-Nitrotoluen	Red	Red	Red	Red	Red	Red	Red	Red	T
Oleik asit (yağ asit)	Red	Red	Red	Red	Red	Red	Red	Red	Xi
Oksalik asit	Red	Red	Red	Red	Red	Red	Red	Red	Xn
Palmitik asit	Red	Red	Red	Red	Red	Red	Red	Red	Xi
Pentaklorofenol	Red	Red	Red	Red	Red	Red	Red	Red	T+, K3
o-Pentan	Red	Red	Red	Red	Red	Red	Red	Red	Xi, F+
Pentaklorofenol (Pentaklorofenol)	Red	Red	Red	Red	Red	Red	Red	Red	Xn, K3
Perklorik asit, %30-70	Red	Red	Red	Red	Red	Red	Red	Red	Cx
Pikrik asit	Red	Red	Red	Red	Red	Red	Red	Red	T
Piperazin	Red	Red	Red	Red	Red	Red	Red	Red	C, S
Polioktilifenil (PCE)	Red	Red	Red	Red	Red	Red	Red	Red	Xn
o-Propandil (Propil alkol)	Red	Red	Red	Red	Red	Red	Red	Red	Xi, F
1,2-Propilensit	Red	Red	Red	Red	Red	Red	Red	Red	T, K, M, F+
Propil	Red	Red	Red	Red	Red	Red	Red	Red	Xn, F
Road Lip® (Vilcof)	Red	Red	Red	Red	Red	Red	Red	Red	Xi
Potasyum nitrat asit, %30-70	Red	Red	Red	Red	Red	Red	Red	Red	Cx
Mariyetik asit %50	Red	Red	Red	Red	Red	Red	Red	Red	T, Cx
Kaynarlayıcı yağ	Red	Red	Red	Red	Red	Red	Red	Red	Xn
Tarıyıcı asit	Red	Red	Red	Red	Red	Red	Red	Red	C
Stiren (Stilbenzen)	Red	Red	Red	Red	Red	Red	Red	Red	Xn
Sülfirik asit, %6-20	Red	Red	Red	Red	Red	Red	Red	Red	Cx
Terpenin	Red	Red	Red	Red	Red	Red	Red	Red	Xi, S
Tetrahidrofur	Red	Red	Red	Red	Red	Red	Red	Red	Xi, F
Toluol	Red	Red	Red	Red	Red	Red	Red	Red	Xn, F
Toluol, 2,4-dihidrojen (TDI)	Red	Red	Red	Red	Red	Red	Red	Red	T+, S, K3
o-Tolüol	Red	Red	Red	Red	Red	Red	Red	Red	T, K
o-Tolüol (o-Tolüol)	Red	Red	Red	Red	Red	Red	Red	Red	Xn
Trikloroasetik	Red	Red	Red	Red	Red	Red	Red	Red	T
Tetrahidrofur (THF)	Red	Red	Red	Red	Red	Red	Red	Red	Xi
Trietilen	Red	Red	Red	Red	Red	Red	Red	Red	C, Xn, F
Tetrahidrofur (THF)	Red	Red	Red	Red	Red	Red	Red	Red	Xn, S
Trikloroasetik asit	Red	Red	Red	Red	Red	Red	Red	Red	T, K, M
Trikloroasetik asit	Red	Red	Red	Red	Red	Red	Red	Red	Cx
Vinil klorür (V-Klorür)	Red	Red	Red	Red	Red	Red	Red	Red	Xn, F+
Vinil klorür gazı (V-Klorür)	Red	Red	Red	Red	Red	Red	Red	Red	T, K, F+
Hidrojenli, %30-70 (Hidrojen asit)	Red	Red	Red	Red	Red	Red	Red	Red	C
Kolun	Red	Red	Red	Red	Red	Red	Red	Red	Xi
Asetik asit (asetik asit)	Red	Red	Red	Red	Red	Red	Red	Red	Cx
Asetik asit asitli	Red	Red	Red	Red	Red	Red	Red	Red	C





## Kimyasal Risk Eldivenleri *Chemical Resistant Gloves*

GUIDE®

Order Nr.  
Sipariş Kodu  
23090

### GUIDE 4012 KİMYASAL ELDİVEN



4121



EN 374-2



AKL



Malzeme : Lateks / Neopren  
Material : Latex / Neoprene

Kalınlık / Thickness : 0,60 mm

Uzunluk / Length : 330 mm

Bedenler / Sizes : **7** **8** **9** **10**

Standart / Certification : CE EN 388, EN 374-2, EN 374-3

120



JKL



EN 374-2



2001

GUIDE®

### GUIDE 4015 GIDA ELDİVENİ

Order Nr.  
Sipariş Kodu  
814010

Malzeme : Nitril

Material : Nitrile

Kalınlık / Thickness : 0,21 mm

Uzunluk / Length : 300 mm

Bedenler / Sizes : **7** **8** **9** **10** **11**

Standart / Certification : CE EN 388, EN 374-2, EN 374-3

120



Kimyasal Risk Eldivenleri *Chemical Resistant Gloves*



GUIDE®

GUIDE 4011 KİMYASAL ELDİVEN

Order Nr.  
Sipariş Kodu  
018601

Malzeme : Nitril

Material : Nitrile

Kalınlık / Thickness : 0,38 mm

Uzunluk / Length : 330 mm

Bedenler / Sizes :

7 8 9 10 11

Standart / Certification : CE EN 388, EN 374-2, EN 374-3

120





## Kimyasal Risk Eldivenleri *Chemical Resistant Gloves*

GUIDE

Order Nr.  
Sipariş Kodu  
23190

### GUIDE 4016 KİMYASAL ELDİVEN

Malzeme : Lateks  
Material : Latex

Kalınlık / Thickness : 0,50 mm

Uzunluk / Length : 350 mm

Bedenler / Sizes : 7 8 9 10

Standart / Certification : CE EN 388, EN 374-2, EN 374-3



1120



EN 374-2



AKL



REACH  
COMPLIANCE



120



REACH  
COMPLIANCE



AKL

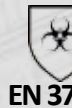

EN 374-2

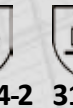

3131

GUIDE

### GUIDE 4013 KİMYASAL ELDİVEN

Order Nr.  
Sipariş Kodu  
24190

Malzeme : Lateks / Neopren  
Material : Latex / Neoprene

Kalınlık / Thickness : 0,75 mm

Uzunluk / Length : 330 mm

Bedenler / Sizes : 7 8 9 10 11

Standart / Certification : CE EN 388, EN 374-2, EN 374-3



120



Kimyasal Risk Eldivenleri *Chemical Resistant Gloves*



GUIDE®

GUIDE 907 KİMYASAL SOĞUK ORTAM ELDİVENİ

Order Nr.  
Sipariş Kodu  
739010



Malzeme / Material : PVC

Uzunluk / Length : 300 mm

Bedenler / Sizes : **10**

Standart / Certification : CE EN 388, EN 374-2,  
EN 374-3, EN 511



Order Nr.  
Sipariş Kodu  
12930

GUIDE®

GUIDE 165 KİMYASAL ELDİVEN



Malzeme : Pamuk, PVC  
Material : Cotton, PVC

Uzunluk / Length : 350 mm

Bedenler / Sizes : **8** **9** **10** **11**

Standart / Certification : CE EN 388, EN 374-2, EN 374-3



Kaydırmaz Kaplama  
Sandy Coating





## Kimyasal Risk Eldivenleri *Chemical Resistant Gloves*

GUIDE

Order Nr.  
Sipariş Kodu  
16790

### GUIDE 167 KESİLMEMEYE DİRENÇLİ KİMYASAL EL DİVEN



4542



EN 374-2



AKL



REACH  
COMPLIANCE

Malzeme : Pamuk, PVC  
Material : Cotton, PVC

Uzunluk / Length : 350 mm



60

Bedenler / Sizes : 9 10 11

Standart / Certification : CE EN 388, EN 374-2, EN 374-3

CUT 5



### EN 374 KİMYASAL TABLOSU / EN 374 CHEMICAL LIST



XXXX

Kod Code	Kimyasal / Chemical	CAS No
A	Metil Alkol / Methanol	67-56-1
B	Aseton / Acetone	67-64-1
C	Asetonitril / Acetonitrile	75-05-8
D	Dikolometan / Dichloromethane	75-09-2
E	Karbon Disülfür / Carbon Disulphide	75-15-0
F	Tolüen / Toluene	108-88-3
G	Diethylamin / Diethylamine	109-89-7
H	Tetrahidrofuran / Tetrahydrofuran	109-99-9
I	Etil Asetat / Etyl Acetate	141-78-6
J	n-Heptan / n-Heptane	142-85-5
K	Sodyum Hidroksit, %40 / Sodium Hydroxide %40	1310-73-2
L	Sülfürik Asit, %96 / Sulphuric Acid %96	7664-93-9



**DÜŞME**  
**KORUYUCULAR**  
FALL  
PROTECTION



Emniyet Kemerleri  
*Harnesses*



Halat ve Diğer Ekipmanlar  
*Lanyards and Accessoires*



## Emniyet Kemerleri *Harnesses*

Order Nr.  
Sipariş Kodu  
710358

### BASIC PARAŞÜT TİPİ EMNİYET KEMERİ



- Bel desteği / *Back support* : ✗  
Konum sabitleme / *Work position* : ✗  
Düşme koruyucu / *Fall-arrest* : ✓  
Oturma pozisyonu / *Sitting harness* : ✗  
Standart / *Certification* : CE EN 361



### PROFI PARAŞÜT TİPİ EMNİYET KEMERİ

Order Nr.  
Sipariş Kodu  
080100

- Bel desteği / *Back support* : ✓  
Konum sabitleme / *Work position* : ✓  
Düşme koruyucu / *Fall-arrest* : ✓  
Oturma pozisyonu / *Sitting harness* : ✓  
Standart / *Certification* : CE EN 358, EN 361, EN 813



## Emniyet Kemerleri *Harnesses*

**ARAN**  
SAFETY

Order Nr.  
Sipariş Kodu  
126111

### ARAN SAFETY PLUS EMNİYET KEMERİ

6

- Bel desteği / *Back support* : ✓
- Konum sabitleme / *Work position* : ✓
- Düşme koruyucu / *Fall-arrest* : ✓
- Oturma pozisyonu / *Sitting harness* : ✓
- Standart / *Certification* : CE EN 358, EN 361



Otomatik Bağlantı Tokaları  
Easy Click Buckles



### PARAŞÜT TİPİ EMNİYET KEMERİ

Order Nr.  
Sipariş Kodu  
025056

8

- Bel desteği  
*Back support* : ✓
- Konum sabitleme  
*Work position* : ✓
- Düşme koruyucu  
*Fall-arrest* : ✓
- Oturma pozisyonu  
*Sitting harness* : ✗
- Standart / *Certification* : CE EN 358, EN 361



## Emniyet Kemerleri *Harnesses*



### BEL TİPİ EMNİYET KEMERİ

- Bel desteği / *Back support* : ✓  
Konum sabitleme / *Work position* : ✓  
Düşme koruyucu / *Fall-arrest* : ✗  
Oturma pozisyonu / *Sitting harness* : ✗  
Standart / *Certification* : CE EN 358

Order Nr.  
Sipariş Kodu  
025056-B



**ARAN**  
SAFETY

Order Nr.  
Sipariş Kodu  
291000

### ARAN SAFETY BEL DESTEK KEMERİ

Açıklama / *Description* : Yük kaldırılırken belin desteklenmesiyle muhtemel ağrı ve sakatlanma riskini en aza indirmek için kullanılır

*Back support belt can be used to protect your back pain when picking up heavy items frequently*

Yıkabilir / *Washable* : ✓

Bedenler / *Sizes* : S M L XL XXL



Halat ve Diğer Ekipmanlar *Lanyards and Accessoires*

ARAN  
SAFETY



Çelik  
Steel

ARAN SAFETY KİLİTLİ KARABİNA

Kilitlenme / Locking : Vidalı kilit / Screwlock system  
Mukavemet / Capacity : 22kN  
Ağız açıklığı / Open size : 18 mm  
Ağırlık / Weight : 165 gr  
Standart / Certification : CE EN 362

Order Nr.  
Sipariş Kodu  
126135



ARAN  
SAFETY

Order Nr.  
Sipariş Kodu  
126180

ARAN SAFETY ÇİFT EMNİYETLİ KANCA

Kilitlenme / Locking : Çift kilit / Double-lock system  
Mukavemet / Capacity : 23kN  
Ağız açıklığı / Open size : 60 mm  
Ağırlık / Weight : 530 gr  
Standart / Certification : CE EN 362



Alüminyum  
Aluminium



ARAN  
SAFETY

Order Nr.  
Sipariş Kodu  
713403



ARAN SAFETY HALAT SABİTLEYİCİ

Açıklama / Description : Halat üzerinde kontrollü iniş/çıkış ve fren imkanı sağlar  
Allows user to move on lanyard and keep position when needed

Halat genişliği / Lanyard size : 12 mm





## Halat ve Diğer Ekipmanlar *Lanyards and Accessoires*

Order Nr.  
Sipariş Kodu  
714302



### ARAN SAFETY HALATLI ŞOK ABSORBER

Lanyard uzunluğu  
*Lanyard length* : 1,50 mt

Maks. şok absorber uzunluğu  
*Max. shock absorber length* : 2,00 mt

Standart / Certification : CE EN 355



Elastik Lanyard  
*Stretchy Lanyard*



### ARAN SAFETY ÇİFT HALATLI ŞOK ABSORBER SET

Lanyard uzunluğu  
*Lanyard length* : 1,50 mt

Maks. şok absorber uzunluğu  
*Max. shock absorber length* : 2,00 mt

Standart / Certification : CE EN 355



Order Nr.  
Sipariş Kodu  
714202



Halat ve Diğer Ekipmanlar *Lanyards and Accessoires*



**ARAN**  
SAFETY

Order Nr.  
Sipariş Kodu  
714318

**ARAN SAFETY STANDART LANYARD**

Çap / Thickness : 12 mm

Uzunluk / Length : 1,50 mt

Standart / Certification : CE EN 354



**ARAN**  
SAFETY

Order Nr.  
Sipariş Kodu  
940007

**ARAN SAFETY ŞOK ABSORBER**

Maksimum uzunluk

Max. Length : 2,00 mt

Standart / Certification : CE EN 355





## Halat ve Diğer Ekipmanlar *Lanyards and Accessoires*

Order Nr.  
Sipariş Kodu  
71413

### TRİPOD



Order Nr.  
Sipariş Kodu  
714820

### GERİ SARMALI DÜŞÜŞ TUTUCU



Halat uzunlukları 6 mt  
Length options : 10 mt  
15 mt  
20 mt

ARAN  
SAFETY



Order Nr.  
Sipariş Kodu  
024004

### YAŞAM HATTI



Standart lanyard uzunluğu  
Standard lanyard length : 100 mt  
Çap / Thickness : 12 mm

Order Nr.  
Sipariş Kodu  
30336

### GÜVENLİK AĞI

Malzeme / Material : Polyester  
Çap / Thickness : 6 mm  
Ebat / Sizes : İsteğe bağlı üretilir  
Optionally produced

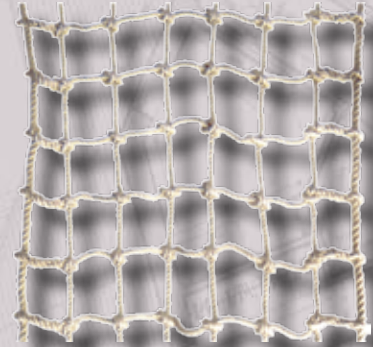



**VÜCUT**  
**KORUYUCULAR**  
**WORKWEAR**



**Sıvı ve Kimyasal Risklere Karşı Koruyucular**  
*Chemical Protection*



**İş Elbiseleri**  
*Working Garments*



**Parka ve Yağmurluklar**  
*Winter Wear*



## Sıvı ve Kimyasal Risklere Karşı Koruyucular *Chemical Protection*

**ARAN**  
SAFETY

Order Nr.  
Sipariş Kodu  
**075600**

50

### ARAN SAFETY C3 TULUM

Açıklama: Kimyasal risklere karşı koruyucu, fermuarlı, dokunmamış kumaş tulum

Description: Overall with elasticated hood. Non-woven material. Fastening with zip under flap

Kapüşon / Hood: ✓

Renkler / Colors: Beyaz / White

Bedenler / Sizes: **M** **L** **XL** **XXL**

Standart / Certification: EN 13982 Tip 5, EN 13034 Tip 6, EN 1073



TYPE 5



TYPE 6



EN 1073



**C3**



**ARAN**  
SAFETY

### ARAN SAFETY C1 TEK KULLANIMLIK TULUM

Açıklama: Gıda uyumlu tek kullanımlık tulum

Description: Overall with elasticated hood. Suitable for food industry

Kapüşon / Hood: ✓

Renkler / Colors: Beyaz / White

Bedenler / Sizes: **M** **L** **XL** **XXL**

Standart / Certification: CAT I

Order Nr.  
Sipariş Kodu  
**052502**

50







**C1**

Sıvı ve Kimyasal Risklere Karşı Koruyucular *Chemical Protection*

Order Nr.  
Sipariş Kodu  
**055602**

**ARAN**  
SAFETY

**ARAN SAFETY C5 TULUM**

      
TYPE 5 TYPE 6 EN 1149 EN 1073 EN 14126

50

Açıklama: Kimyasal risklere karşı koruyucu,  
fermuarlı, dokunmamış kumaş tulum

Description : Overall with elasticated hood. Non-woven material.  
Fastening with zip under flap

Kapüşon / Hood : 

Renkler / Colors : Beyaz / White

Bedenler / Sizes :    

Standart / Certification : EN 13982 Tip 5, EN 13034 Tip 6, EN 1149 Anti-Statik,  
EN 1073, EN 14126

**C5**





## Sıvı ve Kimyasal Risklere Karşı Koruyucular *Chemical Protection*



### TEK KULLANIMLIK ÖNLÜK

Açıklama : Fermuarlı ve cepli tek kullanımlık önlük  
Description : Disposable coat with zip and pocket

Kapüşon / Hood : **X**

Renkler / Colors : Beyaz / White

Bedenler / Sizes : Tek beden / Single size

Standart / Certification : CAT I

Order Nr.  
Sipariş Kodu  
**411231**

50



### MERMERCİ ÖNLÜĞÜ

Order Nr.  
Sipariş Kodu  
**072111**

10



Malzeme / Material : PVC

Ebat / Sizes : 90 cm x 120 cm

Order Nr.  
Sipariş Kodu  
**071312**

20



### PVC ÖNLÜK



Malzeme / Material : PVC

Ebat / Sizes : 70 cm x 100 cm

## İş Elbiseleri *Working Garments*



### SARA CHEMİK KİMYASALA DAYANIKLI ANTI-STATIC ELBİSE



EN 1149 EN 13034

Kumaş : %64 Polyester, %34 Pamuk, %2 Statik-Kontrol (245 gr/m<sup>2</sup>)

Fabric : %64 Polyester, %34 Cotton, %2 Static-Control (245 gr/m<sup>2</sup>)

Renkler / Colors : Gri / Grey

Bedenler / Sizes : **S** **M** **L** **XL** **XXL** **3XL**

Order Nr.  
Sipariş Kodu  
**10431**

QUALITY

### ÇOK CEPLİ İŞ YELEĞİ

Order Nr.  
Sipariş Kodu  
**030300**



Kumaş : %65 Polyester  
%35 Pamuk (245 gr/m<sup>2</sup>)

Fabric : %65 Polyester  
%35 Cotton (245 gr/m<sup>2</sup>)

Renkler : Siyah & Kırmızı  
Colors : Black & Red

Bedenler / Sizes : **S** **M** **L** **XL** **XXL** **3XL**

Order Nr.  
Sipariş Kodu  
**10531**

QUALITY





## İş Elbiseleri Working Garments

Order Nr.  
Sipariş Kodu  
**10515**



### SARA PIORUN ANTI-STATIC ELBİSE



EN 1149

Kumaş : %64 Polyester, %35 Pamuk, %1 Statik-Kontrol (250 gr/m<sup>2</sup>)  
Fabric : %64 Polyester, %35 Cotton, %1 Static-Control (250 gr/m<sup>2</sup>)

Renkler / Colors : Gri-Kırmızı / Grey-Red

Bedenler / Sizes : **S** **M** **L** **XL** **XXL** **3XL**



Order Nr.  
Sipariş Kodu  
**10415**



### SARA WULKAN FLAME RESISTANT ELBİSE



EN 1149 EN 11611 EN 11612

Kumaş : %99 Pamuk & %1 Statik-Kontrol (330 gr/m<sup>2</sup>)  
Fabric : %35 Cotton %1 Static-Control (330 gr/m<sup>2</sup>)

Renkler / Colors : Lacivert / Dark Blue

Bedenler / Sizes : **S** **M** **L** **XL** **XXL** **3XL**

**İsteğe Bağlı Reflektif Şeritler**  
*Optional Reflective Tapes*

**İsteğe Bağlı Kışlık Modeller**  
*Winter Styles are Available*



Order Nr.  
Sipariş Kodu  
**10425**



Order Nr.  
Sipariş Kodu  
**10525**



İş Elbiseleri Working Garments



SARA POSEJDON ELBİSE

Kumaş : %65 Polyester, %35 Pamuk (250 gr/m<sup>2</sup>)

Fabric : %65 Polyester, %35 Cotton (250 gr/m<sup>2</sup>)

Renkler / Colors : Gri-Siyah / Grey-Black

Bedenler / Sizes : **S** **M** **L** **XL** **XXL** **3XL**



Order Nr.  
Sipariş Kodu  
**02022**

QUALITY



Order Nr.  
Sipariş Kodu  
**10422**

QUALITY



Order Nr.  
Sipariş Kodu  
**03022**

QUALITY



Order Nr.  
Sipariş Kodu  
**10522**

QUALITY

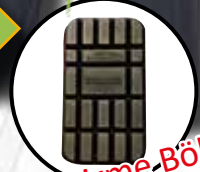

Dizlik Yerleştirme Bölmeleri  
Kneepad Availability



SARA POSEJDON SOFTSHELL

Kumaş : %95 Polyester, %5 Spandeks (350 gr/m<sup>2</sup>)

Fabric : %95 Polyester, %5 Spandex (350 gr/m<sup>2</sup>)

Renkler / Colors : Gri-Siyah / Grey-Black

Bedenler / Sizes : **S** **M** **L** **XL** **XXL** **3XL**

Order Nr.  
Sipariş Kodu  
**04422**

QUALITY





### SARA SKIPER ELBİSE

Kumaş : %65 Polyester, %35 Pamuk (245 gr/m<sup>2</sup>)

Fabric : %65 Polyester, %35 Cotton (245 gr/m<sup>2</sup>)

Renkler / Colors : Kırmızı-Siyah / Red-Black

Bedenler / Sizes : **S** **M** **L** **XL** **XXL** **3XL**

Order Nr.  
Sipariş Kodu  
**03521**

QUALITY



Order Nr.  
Sipariş Kodu  
**10321**

QUALITY



Order Nr.  
Sipariş Kodu  
**10421**

QUALITY

Dizlik Yerleştirme Bölmeleri  
Kneepad Availability



## İş Elbiseleri Working Garments

Order Nr.  
Sipariş Kodu  
**054216**

### İŞ ÖNLÜĞÜ

Kumaş : %65 Polyester & %35 Pamuk  
Fabric : %65 Polyester & %35 Cotton

Renkler : İsteğe bağlı üretilir  
Colors : Optionally produced

Bedenler / Sizes : **S M L XL XXL 3XL**



İsteğinize Bağlı Farklı Kumaş Alternatifleri İle Üretilbilir  
*Available With Different Fabrics*



### SARA MEKANİK ELBİSE

Kumaş : %65 Polyester, %35 Pamuk (250 gr/m<sup>2</sup>)  
Fabric : %65 Polyester, %35 Cotton (250 gr/m<sup>2</sup>)

Renkler / Colors : Kırmızı-Siyah / Red-Black

Bedenler / Sizes : **S M L XL XXL 3XL**



Order Nr.  
Sipariş Kodu  
**10628**

QUALITY



Order Nr.  
Sipariş Kodu  
**10328**

QUALITY







### KLASİK İŞ TULUMU

Order Nr.  
Sipariş Kodu  
299006

Kumaş : %65 Polyester & %35 Pamuk  
Fabric : %65 Polyester & %35 Cotton

Renkler : İsteğe bağlı üretilir  
Colors : Optionally produced

Bedenler / Sizes : **S** **M** **L** **XL** **XXL** **3XL**

İsteğinize Bağlı Farklı Kumaş Alternatifleri İle Üretilbilir  
Available With Different Fabrics



Order Nr.  
Sipariş Kodu  
052724

### BAHÇIVAN TİPİ İŞ TULUMU

Kumaş : %65 Polyester & %35 Pamuk  
Fabric : %65 Polyester & %35 Cotton

Renkler : İsteğe bağlı üretilir  
Colors : Optionally produced

Bedenler / Sizes : **S** **M** **L** **XL** **XXL** **3XL**

İsteğinize Bağlı Farklı Kumaş Alternatifleri İle Üretilbilir  
Available With Different Fabrics



## İş Elbiseleri Working Garments

Order Nr.  
Sipariş Kodu  
262000

### REFLEKTÖRLÜ İŞ TULUMU

Kumaş : %65 Polyester & %35 Pamuk  
Fabric : %65 Polyester & %35 Cotton

Renkler / Colors : İsteğe bağlı üretilir  
Optionally produced

Bedenler / Sizes : **S** **M** **L** **XL** **XXL** **3XL**



### KEP

Renkler / Colors : İsteğe bağlı üretilir  
Optionally produced

Order Nr.  
Sipariş Kodu  
597003



### MONTLU TAKIM

Order Nr.  
Sipariş Kodu  
449005

Kumaş : %65 Polyester & %35 Pamuk  
Fabric : %65 Polyester & %35 Cotton

Renkler : İsteğe bağlı üretilir  
Colors : Optionally produced

Bedenler / Sizes : **S** **M** **L** **XL** **XXL** **3XL**



İsteğinize Bağlı Farklı Kumaş Alternatifleri İle Üretilbilir  
Available With Different Fabrics





Order Nr.  
Sipariş Kodu  
**170008**

### KAYNAKÇI CEKETİ

Kumaş / Fabric : Deri / Leather

Standart / Certification : CE EN 11611



EN 11611



İş Elbiseleri Working Garments



EN 11611



KAYNAKÇI ÖNLÜĞÜ

Kumaş / Fabric : Deri / Leather  
Standart / Certification : CE EN 11611

Order Nr.  
Sipariş Kodu  
073255



Order Nr.  
Sipariş Kodu  
171005

KAYNAKÇI KOLLUĞU

Kumaş / Fabric : Deri / Leather  
Standart / Certification : CE EN 11611



EN 11611

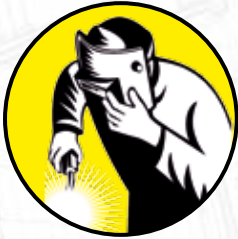

EN 11611



KAYNAKÇI TOZLUĞU

Kumaş / Fabric : Deri / Leather  
Standart / Certification : CE EN 11611

Order Nr.  
Sipariş Kodu  
172002

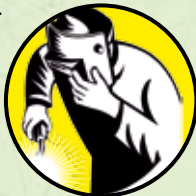



## İş Elbiseleri Working Garments

### ÇOK CEPLİ İŞ YELEĞİ

Kumaş / Fabric : PVC & Polyester / PVC & Polyester

Renkler : Yeşil, lacivert (204987)

Sarı, turuncu (705002)

Colors : Green, dark blue (2049987)

Yellow, orange (705002)

Bedenler / Sizes : **S** **M** **L** **XL** **XXL** **3XL**



WATERPROOF



Order Nr.  
Sipariş Kodu  
**204987**



Order Nr.  
Sipariş Kodu  
**705002**

Reflektif Şeritler  
Reflective Lines



### TIŞÖRT

Kumaş : %65 Polyester & %35 Pamuk

Fabric : %65 Polyester & %35 Cotton

Renkler : İsteğe bağlı üretilir

Colors : Optionally produced

Bedenler / Sizes : **S** **M** **L** **XL** **XXL** **3XL**



Bisiklet Yaka  
Crew Neck

Order Nr.  
Sipariş Kodu  
**965000**

Polo Yaka  
Polo Neck



Order Nr.  
Sipariş Kodu  
**730004**

## İş Elbiseleri Working Garments



Order Nr.  
Sipariş Kodu  
**031200**

### ORMANCI ELBİSESİ

Kumaş : Polyester (Testere kesmez özel dokuma)  
Fabric : Polyester (Chainsaw-protective material)

Renkler / Colors : Yeşil & Turuncu / Green & Orange

Bedenler / Sizes : **S** **M** **L** **XL** **XXL** **3XL**

Standart / Certification : CE EN 381-5



EN 381



WATERPROOF



A



**Kol Altı ve Sırt Havalandırması**  
Ventilation On Back and Under Arms



## İş Elbiseleri Working Garments

Order Nr.  
Sipariş Kodu  
**70203**

### ÇOK CEPLİ MÜHENDİS YELEĞİ

Renkler / Colors : Sarı & Turuncu / Yellow & Orange  
Bedenler / Sizes : **S M L XL XXL 3XL**

10



### REFLEKTÖRLÜ İKAZ YELEĞİ

50

Order Nr.  
Sipariş Kodu  
**702018**



Order Nr.  
Sipariş Kodu  
**702117**



*Ekstra Omuz Şeritleri  
Extra Shoulder Lines*

İş Elbiseleri Working Garments

20

REFLEKTÖRLÜ TIŞÖRT

Kumaş : %100 Polyester nefes alır özel dokuma  
Fabric : %100 Breathable polyester

Renkler / Colors : Sarı & Turuncu / Yellow & Orange

Bedenler / Sizes : **S** **M** **L** **XL** **XXL** **3XL**



Order Nr.  
Sipariş Kodu  
730981



Order Nr.  
Sipariş Kodu  
730998



Polo Yaka  
Polo Neck

REFLEKTÖRLÜ TIŞÖRT

20

Kumaş : %100 Polyester nefes alır özel dokuma  
Fabric : %100 Breathable polyester

Renkler / Colors : Sarı & Turuncu / Yellow & Orange

Bedenler / Sizes : **S** **M** **L** **XL** **XXL** **3XL**



Bisiklet Yaka  
Crew Neck



Order Nr.  
Sipariş Kodu  
730974



Order Nr.  
Sipariş Kodu  
730967





## Parka ve Yağmurluklar Winter Wear

Order Nr.  
Sipariş Kodu  
03010019

### YÜKSEK GÖRÜNÜMLÜ PARKA



WATERPROOF WINDPROOF ISOLATION

Kumaş : %100 Polyester, poliüretan kaplı yırtılmaz 300 D oxford kaplama  
Fabric : %100 Polyester 300D oxford with polyurethane coating

Renkler / Colors : Sarı, Turuncu / Yellow, Orange

Kapüşon / Hood : ✓

Bedenler / Sizes : S M L XL XXL 3XL

Standart / Certification : CE EN20471 Class 3,  
EN343 Class 3-1



S



T



ISOLATION



WINDPROOF



WATERPROOF



### YÜKSEK GÖRÜNÜMLÜ PARKA

Order Nr.  
Sipariş Kodu  
03010073

S

T



Kumaş : %100 Polyester, poliüretan kaplı yırtılmaz 300 D oxford kaplama  
Fabric : %100 Polyester 300D oxford with polyurethane coating

Renkler / Colors : Sarı, Turuncu / Yellow, Orange

Kapüşon / Hood : ✓

Bedenler / Sizes : S M L XL XXL 3XL

Standart / Certification : CE EN20471 Class 3, EN343 Class 3-1

Parka ve Yağmurluklar *Winter Wear*

Order Nr.  
Sipariş Kodu  
03010070

YÜKSEK GÖRÜNÜMLÜ 5 in 1 PARKA

Kumaş : %100 Polyester, poliüretan kaplı yırtılmaz 300 D oxford kaplama

Fabric : %100 Polyester 300D oxford with polyurethane coating

Renkler / Colors : Sarı, Turuncu / Yellow, Orange

Kapüşon / Hood : ✓

Bedenler / Sizes : S M L XL XXL 3XL

Standart / Certification : CE EN20471 Class 3, EN343 Class 3-1



WATERPROOF



WINDPROOF



ISOLATION

10



S

T

Kol Altı ve Sirt Havalandırması  
Ventilation On Back and Under Arms





## Parka ve Yağmurluklar Winter Wear



ISOLATION



WINDPROOF



WATERPROOF



### YÜKSEK GÖRÜNÜMLÜ PARKA

Order Nr.  
Sipariş Kodu  
**704111**

Kumaş : %100 Polyester

Fabric : %100 Polyester

Renkler / Colors : Sarı, Turuncu / Yellow, Orange

Kapüşon / Hood : ✓

Bedenler / Sizes : **S** **M** **L** **XL** **XXL** **3XL**



Order Nr.  
Sipariş Kodu  
**203010**

### KIŞLIK PARKA



WATERPROOF



WINDPROOF



ISOLATION



Kumaş : %100 Polyester

Fabric : %100 Polyester

Renkler / Colors : Lacivert / Dark blue

Kapüşon / Hood : ✓

Bedenler / Sizes : **S** **M** **L** **XL** **XXL** **3XL**



Parka ve Yağmurluklar *Winter Wear*



**YÜKSEK GÖRÜNÜMLÜ TAKIM YAĞMURLUK**



WATERPROOF

Kumaş : %100 Polyester, poliüretan kaplı yırtılmaz 150 D oxford kaplama

Fabric : %100 Polyester 150 D oxford with polyurethane coating

Renkler / Colors : Sarı, Turuncu / Yellow, Orange

Kapüşon / Hood : ✓

Bedenler / Sizes : **S** **M** **L** **XL** **XXL** **3XL**

Order Nr.  
Sipariş Kodu  
**100067**



Order Nr.  
Sipariş Kodu  
**044118**

**YÜKSEK GÖRÜNÜMLÜ YAĞMURLUK**

Kumaş / Fabric : PVC/Polyester/PVC

Renkler / Colors : Turuncu / Orange

Kapüşon / Hood : ✓



WATERPROOF



**Reflektif Şeritler**  
Reflective Lines





## Parka ve Yağmurluklar *Winter Wear*

Order Nr.  
Sipariş Kodu  
**042541**

10

### TULUM YAĞMURLUK

Kumaş / Fabric : PVC  
Renkler / Colors : Haki, lacivert  
Green, dark blue  
Kapüşon / Hood : ✓



WATERPROOF



### TAKIM YAĞMURLUK

Order Nr.  
Sipariş Kodu  
**041445**



WATERPROOF

Kumaş / Fabric : PVC  
Renkler / Colors : Haki, lacivert  
Green, dark blue  
Kapüşon / Hood : ✓

10

Parka ve Yağmurluklar *Winter Wear*

Order Nr.  
Sipariş Kodu  
**044033**

20

**TAKIM YAĞMURLUK**

Kumaş / Fabric : PVC/Polyester  
Renkler / Colors : Haki, lacivert  
Green, dark blue  
Kapüşon / Hood : ✓



WATERPROOF



Çantalı  
With Bag



**PARDESÜ YAĞMURLUK**

Order Nr.  
Sipariş Kodu  
**100715**

20



WATERPROOF

Kumaş / Fabric : PVC/Polyester  
Renkler / Colors : Haki, lacivert  
Green, dark blue  
Kapüşon / Hood : ✓



Çantalı  
With Bag



## Parka ve Yağmurluklar *Winter Wear*



WATERPROOF

### TAKIM YAĞMURLUK

Kumaş / Fabric : PVC/Polyester/PVC  
Renkler / Colors : Haki, lacivert, sarı  
Green, dark blue, yellow  
Kapüşon / Hood : ✓

Order Nr.  
Sipariş Kodu  
**042442**



Order Nr.  
Sipariş Kodu  
**042800**



### CEKET YAĞMURLUK

Kumaş / Fabric : PVC/Polyester/PVC  
Renkler / Colors : Haki, lacivert, sarı  
Green, dark blue, yellow  
Kapüşon / Hood : ✓



WATERPROOF



WATERPROOF



SINGLE USE

### TEK KULLANIMLIK YAĞMURLUK

Kumaş / Fabric : PVC  
Renkler / Colors : Şeffaf, beyaz, mavi, kırmızı, sarı  
Transparent, white, blue, red, yellow  
Kapüşon / Hood : ✓

Order Nr.  
Sipariş Kodu  
**044019**



## Parka ve Yağmurluklar *Winter Wear*



### PARDESÜ YAĞMURLUK

Kumaş / Fabric : PVC

Renkler / Colors : Haki, lacivert  
Green, dark blue

Kapüşon / Hood : ✓

Order Nr.  
Sipariş Kodu  
**041148**



**WATERPROOF**



Order Nr.  
Sipariş Kodu  
**042046**

### PARDESÜ YAĞMURLUK

Kumaş / Fabric : PVC/Polyester/PVC

Renkler / Colors : Haki, lacivert, sarı  
Green, dark blue, yellow

Kapüşon / Hood : ✓



**WATERPROOF**







**AYAK**  
**KORUYUCULAR**  
**FOOT PROTECTION**



Koruyucu Ayakkabılar  
*Low Shoes*



Koruyucu Bot ve Çizmeler  
*High Shoes and Boots*



Günlük Kullanım  
*Daily Use*

## Koruyucu Ayakkabılar Low Shoes

**jalas**  
FOR FEET WITH A TASK

Order Nr.  
Sipariş Kodu  
95080

QUALITY

**JALAS 9508 EXALTER**

**S3**

Taban : PU orta taban, plastik mafsal,  
kauçuk dış taban

Sole : PU midsole, plastic shank, rubber  
outsole

10

Burun koruması  
Protective toecap : ✓

Taban koruması  
Penetration-resistant sole : ✓

Su geçirmez  
Water-resistant upper : ✓

ESD : ✓

Bedenler / Sizes : 36 - 47

Standart / Certification : CE EN ISO 20345:2011, S3 SRC HRO



vibram

Metal  
FREE

MADE  
IN  
EUROPE



Order Nr.  
Sipariş Kodu  
95280

QUALITY





## Koruyucu Ayakkabılar Low Shoes

**jalas**  
FOR FEET WITH A TASK

Order Nr.  
Sipariş Kodu  
**01538**



**S3**

### JALAS 1538 TERRA

Taban : PU orta taban, kauçuk dış taban  
Sole : PU midsole, rubber outsole

Burun koruması  
Protective toecap : ✓

Taban koruması  
Penetration-resistant sole : ✓

Su geçirmez  
Water-resistant upper : ✓

ESD : ✓

Bedenler / Sizes : 35 - 50

Standart / Certification : EN ISO 20345:2011, S3 SRC CI HRO

QUALITY

10



**Metal FREE**

300°C



**jalas**  
FOR FEET WITH A TASK

Order Nr.  
Sipariş Kodu  
**95480**

### JALAS 9548 EXALTER EASYROLL

**S3**

Taban : PU orta taban, plastik mafsal, kauçuk dış taban  
Sole : PU midsole, plastic shank, rubber outsole

Burun koruması  
Protective toecap : ✓

Taban koruması  
Penetration-resistant sole : ✓

Su geçirmez  
Water-resistant upper : ✓

ESD : ✓

Bedenler / Sizes : 36 - 47

Standart / Certification : EN ISO 20345:2011,  
S3 SRC HRO



300°C



**Metal FREE**

10

QUALITY



Koruyucu Ayakkabılar *Low Shoes*



S3

JALAS 7148 ZENIT EVO

**jalas**  
FOR FEET WITH A TASK

Order Nr.  
Sipariş Kodu  
12128

QUALITY

10

MADE  
IN  
EUROPE

Metal  
FREE



Taban: PU orta taban, plastik mafsal, RPU dış taban  
Sole: PU midsole, plastic shank, RPU outsole

Burun koruması  
Protective toecap: ✓

Taban koruması  
Penetration-resistant sole: ✓

Su geçirmez  
Water-resistant upper: ✓

ESD: ✓

Bedenler / Sizes: 35 - 48

Standart / Certification: CE EN ISO 20345:2011,  
S3 SRC



**jalas**  
FOR FEET WITH A TASK

Order Nr.  
Sipariş Kodu  
12277

JALAS 1268 HEAVY DUTY

S3

QUALITY

10

Burun koruması  
Protective toecap: ✓

Taban koruması  
Penetration-resistant sole: ✓

Su geçirmez  
Water-resistant upper: ✓

ESD: ✓

Bedenler / Sizes: 35 - 48

Standart / Certification: EN ISO 20345:2011, S3 SRC HRO



Metal  
FREE

MADE  
IN  
EUROPE

300°C



EasyRoll





## Koruyucu Ayakkabılar Low Shoes



S3

### MENDI PARMA

mendi

Order Nr.  
Sipariş Kodu  
12259

10



Metal  
FREE

Taban / Sole : PU/TPU

Burun koruması / Protective toecap : ✓

Taban koruması / Penetration-resistant sole : ✓

Su geçirmez / Water-resistant upper : ✓

ESD : ✗

Bedenler / Sizes : 36 - 48

Standart / Certification : CE EN ISO 20345:2011,  
S3 SRC

mendi

Order Nr.  
Sipariş Kodu  
12161

### MENDI ENALDO

S3



10

Metal  
FREE

Taban / Sole : PU/TPU

Burun koruması  
Protective toecap : ✓

Taban koruması  
Penetration-resistant sole : ✓

Su geçirmez  
Water-resistant upper : ✓

ESD : ✗

Bedenler  
Sizes : 36 - 48

Standart  
Certification : CE EN ISO 20345:2011,  
S3 SRC



Koruyucu Ayakkabılar *Low Shoes*

mendi

Order Nr.  
Sipariş Kodu  
75800

MENDI ODIN

S3



10



Metal  
FREE

Taban :  
Sole : PU  
Burun koruması  
Protective toecap : ✓  
Taban koruması  
Penetration-resistant sole : ✓  
Su geçirmez  
Water-resistant upper : ✓  
ESD : ✗  
Bedenler  
Sizes : 36 - 48  
Standart  
Certification : CE EN ISO 20345:2011,  
S3 SRC



Metal  
FREE

S3

MENDI MARANTA

mendi

Order Nr.  
Sipariş Kodu  
12278

10

Taban / Sole : PU/TPU  
Burun koruması  
Protective toecap : ✓  
Taban koruması  
Penetration-resistant sole : ✓  
Su geçirmez  
Water-resistant upper : ✓  
ESD : ✗  
Bedenler / Sizes : 36 - 48  
Standart / Certification : CE EN ISO 20345:2011,  
S3 SRC







Koruyucu Ayakkabılar *Low Shoes*

mendi



S1P

MENDI BERGANTIN

Order Nr.  
Sipariş Kodu  
75820



Taban

Sole : PU/TPU

Burun koruması

Protective toecap : ✓

Taban koruması

Penetration-resistant sole : ✓

Su geçirmez

Water-resistant upper : ✗

ESD : ✗

Bedenler

Sizes : 36 - 48

Standart CE EN ISO 20345:2011,

Certification : S1P SRC



ARAN

Order Nr.  
Sipariş Kodu  
122199

ARAN SAFETY BASIC

S2



Taban / Sole : PU/PU

Burun koruması

Protective toecap : ✓

Taban koruması

Penetration-resistant sole : ✗

Su geçirmez

Water-resistant upper : ✓

ESD : ✗

Bedenler / Sizes : 40 - 45

Standart / Certification : CE EN ISO 20345:2011,

S1 SRC



Order Nr.  
Sipariş Kodu  
121192



## Koruyucu Ayakkabılar Low Shoes



S1P

### MENDI BATO

mendi

Order Nr.  
Sipariş Kodu  
75810



Taban / Sole : PU/TPU

Burun koruması / Protective toecap : ✓

Taban koruması / Penetration-resistant sole : ✓

Su geçirmez / Water-resistant upper : ✗

ESD : ✗

Bedenler / Sizes : 36 - 48

Standart / Certification : CE EN ISO 20345:2011,  
S1P SRC



**jalas**  
FOR FEET WITH A TASK

Order Nr.  
Sipariş Kodu  
12267

### JALAS 7128 ZENIT EVO

S1P



Taban : Plastik mafsal, RPU dış taban  
Sole : Plastic shank, RPU outsole

Burun koruması  
Protective toecap : ✓

Taban koruması  
Penetration-resistant sole : ✓

Su geçirmez  
Water-resistant upper : ✗

ESD : ✓

Bedenler / Sizes : 35 - 48

Standart / Certification : EN ISO 20345:2011,  
S1 P SRC



**Metal  
FREE**



## Koruyucu Ayakkabılar *Low Shoes*

**mendi**

Order Nr.  
Sipariş Kodu  
**12127**

### MENDI KENTIA

**S1P**



10



**Metal  
FREE**

Taban  
Sole : PU/TPU

Burun koruması  
Protective toecap : ✓

Taban koruması  
Penetration-resistant sole : ✓

Su geçirmez  
Water-resistant upper : ✗

ESD : ✗

Bedenler  
Sizes : 36 - 48

Standart CE EN ISO 20345:2011,  
Certification : S1P SRC



**mendi**

Order Nr.  
Sipariş Kodu  
**12121**



**S1P**

### MENDI YUCA

Taban / Sole : PU/TPU

Burun koruması / Protective toecap : ✓

Taban koruması / Penetration-resistant sole : ✓

Su geçirmez / Water-resistant upper : ✗

ESD : ✗

Bedenler / Sizes : 36 - 48

Standart / Certification : CE EN ISO 20345:2011,  
S1P SRC



10



**Metal  
FREE**



## Koruyucu Ayakkabılar Low Shoes

ARAN  
SAFETY



### ARAN SAFETY SÜET AYAKKABI

Order Nr.  
Sipariş Kodu  
12229



Taban / Sole : PU/TPU

Burun koruması / Protective toecap : ✓

Taban koruması / Penetration-resistant sole : ✗

Su geçirmez / Water-resistant upper : ✗

ESD : ✗

Bedenler / Sizes : 40 - 45

Standart / Certification : CE EN ISO 20345:2011,  
S1 SRC



**jalas**  
FOR FEET WITH A TASK

Order Nr.  
Sipariş Kodu  
95000

### JALAS 9500 EXALTER SUMMER S1

QUALITY



Burun koruması  
Protective toecap : ✓

Taban koruması  
Penetration-resistant sole : ✗

Su geçirmez  
Water-resistant upper : ✗

ESD : ✓

Bedenler / Sizes : 36 - 47

Standart / Certification : CE EN ISO 20345:2011, S1 SRC HRO



vibram

Metal  
FREE



Koruyucu Ayakkabılar *Low Shoes*

**jalas**  
FOR FEET WITH A TASK

Order Nr.  
Sipariş Kodu  
09538

QUALITY

10



Metal  
FREE

**JALAS 9538 EXALTER EASYROLL S1P**

Taban : PU orta taban, plastik mafsal, kauçuk dış taban  
Sole : PU midsole, plastic shank, rubber outsole

- Burun koruması  
Protective toecap : ✓  
Taban koruması  
Penetration-resistant sole : ✓  
Su geçirmez  
Water-resistant upper : ✗  
ESD : ✓  
Bedenler / Sizes : 36 - 47

Standart / Certification : CE EN ISO 20345:2011, S1P SRC HRO



**jalas**  
FOR FEET WITH A TASK

Order Nr.  
Sipariş Kodu  
15100

QUALITY

10



Metal  
FREE

S1

**JALAS 1510 SANDALET**

Taban : PU orta taban, plastik mafsal, kauçuk dış taban  
Sole : PU midsole, plastic shank, rubber outsole

- Burun koruması  
Protective toecap : ✓  
Taban koruması  
Penetration-resistant sole : ✗  
Su geçirmez  
Water-resistant upper : ✗  
ESD : ✓  
Bedenler  
Sizes : 36 - 47

Standart / Certification : CE EN ISO 20345:2011,  
S1 SRC HRO





## Koruyucu Ayakkabılar Low Shoes

mendi

Order Nr.  
Sipariş Kodu  
01207

### MENDI GALEON

S1P



Taban / Sole : PU/PU

Burun koruması  
Protective toecap : ✓



Taban koruması  
Penetration-resistant sole : ✓

Su geçirmez  
Water-resistant upper : ✗

ESD : ✗

Bedenler / Sizes : 36 - 48

Standart / Certification : CE EN ISO 20345:2011,  
S1P SRC

Metal  
FREE



mendi

Order Nr.  
Sipariş Kodu  
75840



S1P

### MENDI MARTE

Taban / Sole : PU/TPU

Burun koruması / Protective toecap : ✓

Taban koruması / Penetration-resistant sole : ✓

Su geçirmez / Water-resistant upper : ✗

ESD : ✗

Bedenler / Sizes : 36 - 48

Standart / Certification : CE EN ISO 20345:2011,  
S1P SRC



Metal  
FREE



Koruyucu Ayakkabılar *Low Shoes*

mendi

Order Nr.  
Sipariş Kodu  
75830



S1P

MENDI ONIX

Taban / Sole : PU/TPU

Burun koruması / Protective toecap : ✓

Taban koruması / Penetration-resistant sole : ✓

Su geçirmez / Water-resistant upper : ✗

ESD : ✗

Bedenler / Sizes : 36 - 48

Standart / Certification : CE EN ISO 20345:2011,  
S1P SRC

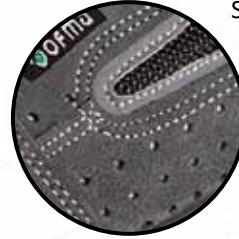

Metal  
FREE



mendi

Order Nr.  
Sipariş Kodu  
12201

MENDI CARABELA

S1P



Taban / Sole : PU/PU

Burun koruması  
Protective toecap : ✓

Taban koruması  
Penetration-resistant sole : ✓

Su geçirmez  
Water-resistant upper : ✗

ESD : ✗

Bedenler / Sizes : 36 - 48

Standart / Certification : CE EN ISO 20345:2011,  
S1P SRC

10

Metal  
FREE





## Koruyucu Ayakkabılar Low Shoes



S1P

JALAS 6418 BIO

**jalas**  
FOR FEET WITH A TASK

Order Nr.  
Sipariş Kodu  
06418

QUALITY

10

MADE IN EUROPE

Metal FREE



Taban : Plastik mafsal, PU dış taban  
Sole : Plastic shank, PU outsole

Burun koruması  
Protective toecap : ✓

Taban koruması  
Penetration-resistant sole : ✓

Su geçirmez  
Water-resistant upper : ✗

ESD : ✓

Bedenler / Sizes : 36 - 47

Standart / Certification : EN ISO 20345:2011, S1 P SRC

mendi

Order Nr.  
Sipariş Kodu  
12281

MENDI AMON

S2



MADE IN EUROPE

10

30

Taban / Sole : PU FOOD SOLE

Burun koruması  
Protective toecap : ✓

Taban koruması  
Penetration-resistant sole : ✗

Su geçirmez  
Water-resistant upper : ✓

ESD : ✗

Bedenler / Sizes : 36 - 46

Standart / Certification : CE EN ISO 20345:2011,  
S2 SRC



Koruyucu Bot ve Çizmeler *High Shoes and Boots*

mendi

Order Nr.  
Sipariş Kodu  
12120

MENDI BRULOTE

S1P



10



Taban  
Sole : PU/TPU  
Burun koruması  
Protective toecap : ✓  
Taban koruması  
Penetration-resistant sole : ✓  
Su geçirmez  
Water-resistant upper : ✗  
ESD : ✗

Bedenler  
Sizes : 36 - 48  
Standart  
Certification : CE EN ISO 20345:2011,  
S1P SRC



mendi

Order Nr.  
Sipariş Kodu  
12007



S1P

MENDI CLIPER



Taban / Sole : PU/TPU  
Burun koruması  
Protective toecap : ✓  
Taban koruması  
Penetration-resistant sole : ✓  
Su geçirmez  
Water-resistant upper : ✗  
ESD : ✗

Bedenler / Sizes : 36 - 48  
Standart / Certification : CE EN ISO 20345:2011,  
S1P SRC



10





## Koruyucu Bot ve Çizmeler High Shoes and Boots

mendi

Order Nr.  
Sipariş Kodu  
12272

### MENDI MALVA

S1P



10

Taban / Sole : PU/TPU

Burun koruması  
Protective toecap : ✓

Taban koruması  
Penetration-resistant sole : ✓

Su geçirmez  
Water-resistant upper : ✗

ESD : ✗

Bedenler / Sizes : 36 - 48

Standart / Certification : CE EN ISO 20345:2011,  
S1P SRC



Metal  
FREE



S2

### JALAS 3150 TREK

Taban : PU orta taban, plastik mafsals,  
kauçuk dış taban

Sole : PU midsole, plastic shank, rubber  
outsole

Burun koruması  
Protective toecap : ✓

Taban koruması  
Penetration-resistant sole : ✗

Su geçirmez  
Water-resistant upper : ✓

ESD : ✓

Bedenler / Sizes : 36 - 47

Standart  
Certification : EN ISO 20345:2011, S2 HRO SRB

jalas  
FOR FEET WITH A TASK

Order Nr.  
Sipariş Kodu  
31500

QUALITY

10



Metal  
FREE



Koruyucu Bot ve Çizmeler *High Shoes and Boots*

**jalas**  
FOR FEET WITH A TASK

Order Nr.  
Sipariş Kodu  
**18180**



300°C

**S3**

**JALAS 1818 DRYLOCK**

Taban : PU orta taban, kauçuk dış taban  
Sole : PU midsole, rubber outsole

Burun koruması  
Protective toecap : ✓

Taban koruması  
Penetration-resistant sole : ✓

Su geçirmez  
Water-resistant upper : ✓

ESD : ✓

Bedenler / Sizes : 36 - 48

Standart : EN ISO 20345:2011, S3 SRC CI WR  
Certification : HRO

QUALITY

10

MADE  
IN  
EUROPE

**Metal  
FREE**



**jalas**  
FOR FEET WITH A TASK

Order Nr.  
Sipariş Kodu  
**18280**

**JALAS 1828 JUPITER**

**S3**

Taban : PU orta taban, kauçuk dış taban  
Sole : PU midsole, rubber outsole

Burun koruması  
Protective toecap : ✓

Taban koruması  
Penetration-resistant sole : ✓

Su geçirmez  
Water-resistant upper : ✓

ESD : ✓

Bedenler / Sizes : 35 - 50

Standart / Certification : CE EN ISO 20345:2011,  
S3 SRC CI HRO



300°C

QUALITY

10

MADE  
IN  
EUROPE

**Metal  
FREE**





## Koruyucu Bot ve Çizmeler High Shoes and Boots



S3

### JALAS 6438 TEMPERA

**jalas**  
FOR FEET WITH A TASK

Order Nr.  
Sipariş Kodu  
64380

QUALITY

10

MADE IN EUROPE

Metal FREE



Taban : Plastik mafsal, PU dış taban  
Sole : Plastic shank, PU outsole

Burun koruması  
Protective toecap : ✓

Taban koruması  
Penetration-resistant sole : ✓

Su geçirmez  
Water-resistant upper : ✓

ESD : ✓

Bedenler / Sizes : 36 - 47

Standart / Certification : EN ISO 20345:2011, S3 SRC

**mendi**

Order Nr.  
Sipariş Kodu  
12199

### MENDI HIEDRA

S3



10

MADE IN EUROPE

Metal FREE

Taban / Sole : PU/TPU

Burun koruması  
Protective toecap : ✓

Taban koruması  
Penetration-resistant sole : ✓

Su geçirmez  
Water-resistant upper : ✓

ESD : ✗

Bedenler / Sizes : 36- 48

Standart / Certification : CE EN ISO 20345:2011,  
S3 SRC



## Koruyucu Bot ve Çizmeler *High Shoes and Boots*

mendi

Order Nr.  
Sipariş Kodu  
12279

### MENDI BARI

S3



10

Taban / Sole : PU/PU

Burun koruması  
Protective toecap : ✓

Taban koruması  
Penetration-resistant sole : ✓

Su geçirmez  
Water-resistant upper : ✓

ESD : ✗

Bedenler / Sizes : 36 - 48

Standart / Certification : CE EN ISO 20345:2011,  
S3 SRC



**Metal  
FREE**



S3

### MENDI AENEAS

mendi

Order Nr.  
Sipariş Kodu  
12130

Taban / Sole : PU/TPU

Burun koruması  
Protective toecap : ✓

Taban koruması  
Penetration-resistant sole : ✓

Su geçirmez  
Water-resistant upper : ✓

ESD : ✗

Bedenler / Sizes : 36 - 48

Standart  
Certification : EN ISO 20345:2011, S3 SRC

10



**Metal  
FREE**





## Koruyucu Bot ve Çizmeler High Shoes and Boots

**jalas**  
FOR FEET WITH A TASK

Order Nr.  
Sipariş Kodu  
18480

QUALITY

10



Metal  
FREE

### JALAS 1848K TITAN

S3

Taban : PU orta taban, plastik mafsals,  
kauçuk dış taban

Sole : PU midsole, plastic shank, rubber  
outsole

Burun koruması  
Protective toecap : ✓

Taban koruması  
Penetration-resistant sole : ✓

Su geçirmez  
Water-resistant upper : ✓

ESD : ✓

Bedenler / Sizes : 35 - 50

Standart / Certification : EN ISO 20345:2011, S3 SRC CI HRO



S3

### MENDI ODIN

Order Nr.  
Sipariş Kodu  
12122

10



Metal  
FREE

Taban :  
Sole : PU

Burun koruması  
Protective toecap : ✓

Taban koruması  
Penetration-resistant sole : ✓

Su geçirmez  
Water-resistant upper : ✓

ESD : ✗

Bedenler  
Sizes : 36 - 48

Standart  
Certification : CE EN ISO 20345:2011,  
S3 SRC



Koruyucu Bot ve Çizmeler High Shoes and Boots



S3

MENDI PALAS

mendi

Order Nr.  
Sipariş Kodu  
12131

Taban / Sole : PU/TPU

Burun koruması  
Protective toecap : ✓

Taban koruması  
Penetration-resistant sole : ✓

Su geçirmez  
Water-resistant upper : ✓

ESD : ✗

Bedenler / Sizes : 36 - 48

Standart / Certification : EN ISO 20345:2011, S3 SRC



**jalas**  
FOR FEET WITH A TASK

Order Nr.  
Sipariş Kodu  
12280

QUALITY



Burun koruması  
Protective toecap : ✓

Taban koruması  
Penetration-resistant sole : ✓

Su geçirmez  
Water-resistant upper : ✓

ESD : ✓

Bedenler / Sizes : 35 - 50

Standart / Certification : EN ISO 20345:2011, S3 SRC CI HRO

JALAS 1898 WINTER KING

S3

Taban : PU orta taban, plastik mafsal,  
kauçuk dış taban

Sole : PU midsole, plastic shank, rubber  
outsole



Metal  
FREE





## Koruyucu Bot ve Çizmeler High Shoes and Boots



S3

### JALAS 1728 ZENIT EASYROLL

**jalas**  
FOR FEET WITH A TASK

Order Nr.  
Sipariş Kodu  
17280

QUALITY

10

MADE IN EUROPE

Metal FREE

Taban : PU orta taban, plastik mafsal, RPU dış taban

Sole : PU midsole, plastic shank, RPU outsole

Burun koruması

Protective toecap : ✓

Taban koruması

Penetration-resistant sole : ✓

Su geçirmez

Water-resistant upper : ✓

ESD : ✓

Bedenler / Sizes : 36 - 47

Standart

Certification : EN ISO 20345:2011, S3 SRC CI



EasyRoll

boq



**jalas**  
FOR FEET WITH A TASK

Order Nr.  
Sipariş Kodu  
18580

QUALITY

10

MADE IN EUROPE

Metal FREE

### JALAS 1858 POLAR

S3

Taban : PU orta taban, kauçuk dış taban

Sole : PU midsole, rubber outsole

Burun koruması

Protective toecap : ✓

Taban koruması

Penetration-resistant sole : ✓

Su geçirmez

Water-resistant upper : ✓

ESD : ✗

Bedenler / Sizes : 39 - 48

Standart / Certification : EN ISO 20345:2011, S3 SRC CI HRO



300°C



Koruyucu Bot ve Çizmeler *High Shoes and Boots*



S5

YÜNLÜ PVC ÇİZME

Order Nr.  
Sipariş Kodu  
12270

Taban / Sole : PVC

Burun koruması / Protective toecap : ✓

Taban koruması / Penetration-resistant sole : ✓

Su geçirmez / Water-resistant upper : ✓

Bedenler / Sizes : 36 - 48

Standart / Certification : CE EN ISO 20345:2011, S5 SRC

10



Order Nr.  
Sipariş Kodu  
12546

PVC ÇİZME

S5

Taban / Sole : PU

Burun koruması  
Protective toecap : ✓

Taban koruması  
Penetration-resistant sole : ✓

Su geçirmez  
Water-resistant upper : ✓

Bedenler / Sizes : 39 - 48

Standart / Certification : CE EN ISO 20345:2011, S5 SRC

10





## Koruyucu Bot ve Çizmeler High Shoes and Boots



S5

### PVC ÇİZME

Order Nr.  
Sipariş Kodu  
020400

Taban / Sole : PVC

Burun koruması / Protective toecap : ✓

Taban koruması / Penetration-resistant sole : ✓

Su geçirmez / Water-resistant upper : ✓

Bedenler / Sizes : 36 - 48

Standart / Certification : CE EN ISO 20345:2011, S5 SRC



Order Nr.  
Sipariş Kodu  
020400-P

Order Nr.  
Sipariş Kodu  
124193

### PVC ÇİZME



Taban / Sole : PVC

Burun koruması  
Protective toecap : ✗

Taban koruması  
Penetration-resistant sole : ✗

Su geçirmez  
Water-resistant upper : ✓

Bedenler / Sizes : 38 - 45



Order Nr.  
Sipariş Kodu  
124193-P



Koruyucu Bot ve Çizmeler *High Shoes and Boots*

**jalas**  
FOR FEET WITH A TASK

Order Nr.  
Sipariş Kodu  
15780

**JALAS 1578 FIRE & RESCUE**



Taban : PU orta taban, kauçuk dış taban  
Sole : PU midsole, rubber outsole



QUALITY

10



Metal  
FREE

Burun koruması  
Protective toecap : ✓

Taban koruması  
Penetration-resistant sole : ✓

Su geçirmez  
Water-resistant upper : ✓

ESD : ✗

Bedenler / Sizes : 38 - 50

Standart / Certification : EN 15090:2012, F1PA SRC CI



ProNose ayak parmağı takviyesi, geniş kalıp, dikişlerde kısa süre 427° C sıcaklığa (maksimum çalışma sınırı) ve uzun süre 204° C sıcaklığa (sürekli çalışma sınırı) dayanan KEVLAR® iplik, ısıya dayanıklı üst bölüm, ısıya dayanıklı dış taban, yağa dayanıklı dış taban, antistatik özelliğindedir, dolgulu bot gövdesi, havalandırılmalı iç taban, bağcık delikleri, su itici, yansıtıcı, özel olarak tasarlanmış detaylar, çift darbe emme bölgesi

ProNose toe reinforcement, wide fit, KEVLAR® thread in the seams wich resists 427° C short-term heat exposure (max operating limit) and 204° C longer-term heat exposure (constant operating limit), heat-resistant upper, heat-resistant outsole, oil-resistant outsole, anti-static properties, padded boot shaft, ventilating insole, pull loops, water repellent, reflector, specially designed details, double shock absorpction zones



Günlük Kullanım *Daily Use*



## PVC ÇİZME

Order Nr.  
Sipariş Kodu  
**125091**

10



- Taban / Sole : PVC
- Burun koruması / *Protective toecap* : **X**
- Taban koruması / *Penetration-resistant sole* : **X**
- Su geçirmez / *Water-resistant upper* : **✓**
- Bedenler / *Sizes* : 42 - 45

Order Nr.  
Sipariş Kodu  
**126098**

10



SINGLE USE

## GALOŞ

Malzeme / *Material* : PVC

Bedenler / *Sizes* : Tek beden / *One size*

Order Nr.  
Sipariş Kodu  
**99002**

1000

Günlük Kullanım *Daily Use*

**jalas**  
FOR FEET WITH A TASK

Order Nr.  
Sipariş Kodu  
**12210**

QUALITY

10



01

**JALAS 5002 MENU BLACK**

Taban / Sole : PU

Burun koruması

Protective toecap : **X**

Taban koruması

Penetration-resistant sole : **X**

Su geçirmez

Water-resistant upper : **X**

ESD : **✓**

Bedenler / Sizes : 36 - 47

Standart / Certification : CE EN ISO 20347:2012, 01 SRC



**jalas**  
FOR FEET WITH A TASK

Order Nr.  
Sipariş Kodu  
**020101**

QUALITY

10



**JALAS SPOC**

01



Taban / Sole : EVA Kauçuk / EVA Rubber

Burun koruması

Protective toecap : **X**

Taban koruması

Penetration-resistant sole : **X**

Su geçirmez

Water-resistant upper : **X**

ESD : **✓**

Bedenler / Sizes : 35 - 48

Standart / Certification : CE EN ISO 20345:2011,  
01 SRC







## Semboller Ne Anlama Geliyor?



Burun koruyucu  
Toecap



Darbe emici topuk  
Shock absorbing



Taban koruyucu  
Nail protection



Fermuarlı  
Zipper



Su geçirmez  
Water repellent



Ağırlık dengeleyici  
Stabilizator



Yağa dirençli taban  
Oil-resistant outsole



Anti-statik  
Anti-static properties



Isıya dirençli taban  
Heat-resistant outsole



ESD

	S1	S1P	S2	S3	S4	S5
	✓	✓	✓	✓	✓	✓
		✓		✓		✓
			✓	✓	✓	✓

## Bir Ayakkabıdan Daha Fazlası

Dolgu boğaz  
Padded collar

Dil  
Tongue



İç taban  
Insole

Darbe emici topuk  
Energy absorbing seat region

Taban  
Outsole

Koruyucu ara taban  
Penetration resistant midsole

Anti-Statik taban  
Antistatic thread

Yama  
Vamp

Saya astar  
Vamp Lining

Su geçirmez astar  
Waterproof membrane

Kauçuk boynuz yapı  
Rubber scuff cap

Burun koruyucu  
Toecap



**ELEKTRİK**  
**EKİPMANLARI**  
ELECTRICAL  
SAFETY



Order Nr.  
Sipariş Kodu  
**011684**

## ELEKTRİKÇİ BARETİ

Açıklama / Description : Elektrik izole emniyet bareti  
Insulating helmet for electric works

Renkler / Colors : 

Ayarlama / Adjustment : Çevirme tip / Wheel ratchet

Astar / Suspension : Tekstil / Textile

Havalandırma / Ventilation : 

Çene bağı / Chin strap : 

Malzeme / Material : ABS

Kapasite / Capacity : 30 kV

Standart / Certification : CE EN 397



## ELEKTRİK İZOLE ELDİVEN

Order Nr.  
Sipariş Kodu  
**011608**

Malzeme / Material : Kauçuk / Rubber

Kalınlık / Thickness : 0,5 mm - 3,6 mm

Uzunluk / Length : 280 mm - 410 mm

Standart / Certification : CE EN 60903:2003 - IEC 60903:2002



CLASS	MAX. VOLT
00	500V
0	1000V
1	7500V
2	17000V
3	26500V
4	36000V





## ELEKTRİK İZOLE ÇİZME

Order Nr.  
Sipariş Kodu  
124704

Taban / Sole : Kauçuk / Rubber

Burun koruması / Protective toecap : ✓

Taban koruması / Penetration-resistant sole : ✓

Bedenler / Sizes : 40 - 45

Kapasite / Capacity : 36 kV

Standart / Certification : CE EN20345 EN13287



**Metal  
FREE**

Order Nr.  
Sipariş Kodu  
011677

## KURTARMA İSTANKASI

Açıklama / Description : Elektrik izole kurtarma istankası  
Electrical rescue stick

Uzunluk / Length : 1,75 mt

Kapasite / Capacity : 45 kV



## KABLO KESİCİ

Order Nr.  
Sipariş Kodu  
011691

Açıklama / Description : Elektrik izole kablo kesici  
Insulated cable cutter

Kapasite / Capacity : 25 kV





Order Nr.  
Sipariş Kodu  
001197



## ELEKTRİK İZOLE SEHPA

**Açıklama** Teknisyen, 1. kategori işlerde çalışırken veya el kontrollü 2.ve 3. kategori (kesiciler, elektrik anahtarları, vs.) ayırıcı aletleri kullanırken onlara yalıtım sağlar  
**Description :** Used to provide insulation for a technician during 1st category work or operating on manually operated 2nd or 3rd category separating instruments



Order Nr.  
Sipariş Kodu  
8521



## ASMA KİLİT

**Malzeme / Material :** ABS  
**Ağız açıklığı / Open size :** 38 mm



Order Nr.  
Sipariş Kodu  
001173



## İZOLE HALI

**Kalınlık / Thickness :** 3,0 mm - 4,5 mm  
**Kapasite / Capacity :** 28 mm - 410 mm  
**Standart / Certification :** CE EN 60243





## ELEKTRİKÇİ AYAKKABISI

Order Nr.  
Sipariş Kodu  
20T22



Taban / Sole : Kauçuk / Rubber

Burun koruması  
Protective toecap : ✓

Taban koruması  
Penetration-resistant sole : ✓

Su geçirmez  
Water-resistant upper : ✓

ESD : ✗

Bedenler / Sizes : 39 - 47

Standart / Certification : CE EN ISO 20345:2011,  
S3 SRC HRO



**Metal  
FREE**



Order Nr.  
Sipariş Kodu  
20T22E

## ELEKTRİKÇİ BOTU

S3



Taban / Sole : Kauçuk / Rubber

Burun koruması  
Protective toecap : ✓

Taban koruması  
Penetration-resistant sole : ✓

Su geçirmez  
Water-resistant upper : ✓

ESD : ✗

Bedenler / Sizes : 36 - 48

Standart / Certification : CE EN ISO 20345:2011,  
S3 SRC HRO



**Metal  
FREE**







**YANGIN**  
**GÜVENLÜĞÜ**  
FIRE  
SECURITY



## İTFAİYECİ ELBİSESİ

Order Nr.  
Sipariş Kodu  
100203

Kumaş / Fabric : NOMEX

Standart / Certification : CE EN 469



Reflektif Şeritler  
Reflective Lines



Order Nr.  
Sipariş Kodu  
100005

## YANGIN ELBİSESİ

Kumaş / Fabric : Çift ayna / Dual mirror

Standart / Certification : CE EN 1486





Order Nr.  
Sipariş Kodu  
HPS6200

## İTFAİYECİ BAŞLIĞI



Ağırlık / Weight : 1365 gr

Standart / Certification : CE EN 443



## ÖRME BAŞLIK

Order Nr.  
Sipariş Kodu  
10010



Kumaş / Fabric : NOMEX

Standart / Certification : CE EN 13911



Order Nr.  
Sipariş Kodu  
100173

## İTFAİYECİ ELDİVENİ



Malzeme / Material : Kevlar

Standart / Certification : CE EN 659



## İTFAİYECİ ÇİZMESİ

Order Nr.  
Sipariş Kodu  
100197



300°C



Malzeme / Material : Kauçuk / Rubber

Standart / Certification : CE EN 15090 F2IS HI3 P  
T CI, EN 20345:2004 +  
A1:2007 SRA SB P CI E,  
EN 13287



Order Nr.  
Sipariş Kodu  
999937

### ARABALI YANGIN SÖNDÜRÜCÜ

Yangın Tipi A-B-C



Açıklama Arabalı yangın tüpü  
Description : Wheeled Fire Extinguisher

Malzeme Köpük veya kuru toz  
Material : Foam or dry powder

Kapasite / Capacity : 50 kg. / 18 bar

### YANGIN BATTANIYESİ

Order Nr.  
Sipariş Kodu  
100029

Çantalı  
With Case



Açıklama Yangına müdahale battaniyesi  
Description : Flame resistant fire smothering blanket

Ebat / Size : 160 cm x 200 cm



### YANGIN SÖNDÜRME CİHAZI

Order Nr.  
Sipariş Kodu  
999968

Açıklama Standart yangın tüpü  
Description : Fire Extinguisher

Malzeme Köpük veya kuru toz  
Material : Foam or dry powder

Kapasite / Capacity : 18 bar







## ACİL DURUM EKİPMAN DOLABI

Order Nr.  
Sipariş Kodu  
**100159**

Açıklama : Doğal afetler için acil durum müdahale ve yardım çağırma dolabı  
Description : Rescue and help call station for emergency states

Malzeme / Material : Metal & cam / Metal & glass

Ebat / Size : (h) 100 cm x 92 cm x 42 cm



### İçindekiler / Contents

- Megafon
- Radyo
- El feneri
- Baret
- Düdük
- İlk yardım çantası
- Yangın kaçış maskesi
- İtfaiyeci elbisesi
- İtfaiyeci eldiveni
- Deri iş eldiveni
- İtfaiyeci çizmesi
- Reflektörlü yelek
- Solunum seti
- Yangın battaniyesi
- Yangın tüpü
- Kazma
- Çekiç
- Megaphone
- Radio
- Flashlight
- Helmet
- Whistle
- First aid box
- Fire escape hood
- Firefighting suit
- Firefighting glove
- Leather glove
- Firefighting boot
- Safety vest
- SCBA set
- Fire blanket
- Fire extinguisher
- Pickaxe
- Hammer

Order Nr.

Sipariş Kodu  
**099903**

## İŞILDAYAN YER ETİKETİ

Açıklama : 20 saniye ışık depolaması ile 1 saat parlak kalabilen acil çıkış yer etiketi  
Description : Emergency floor sign, 1 hours glow in the dark after 20 seconds light saving

Yapışkanlı / Adhesive : ✓

Lümenli / Photoluminescent : ✓



## İŞILDAYAN ACİL DURUM LEVHALARI



Açıklama / Description : 20 saniye ışık depolaması ile 3 saat parlak kalabilen acil durum levhası  
Emergency sign, 3 hours glow in the dark after 20 seconds light saving

Yapışkanlı / Adhesive : ✓

İşıklı / Light : ✗

Lümenli / Photoluminescent : ✓

## İŞIKLI ACİL DURUM LEVHALARI



Çift Taraflı  
Double Face

Açıklama / Description : 180 dk yanma kapasiteli, çift taraflı acil çıkış levhası  
180 min lighting exit sign with double face

Yapışkanlı / Adhesive : ✗

İşıklı / Light : ✓

Lümenli / Photoluminescent : ✗





**ÇEVRE**  
**GÜVENLİĞİ**  
ENVIRONMENT  
SAFETY

## 25 CM X 35 CM İKAZ LEVHALARI





## 25 CM X 35 CM İKAZ LEVHALARI



041



042



043



044



045



046

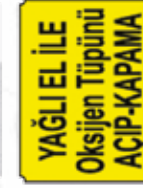

047



048



049



050



051



052



053

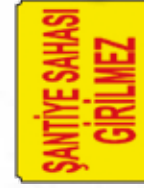

054



055

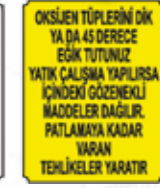

056



057



058



059



060



061



062



063



064



065



066



067



068



069



070



071



072



073



074



075



076



077



078



079



080

25 CM X 35 CM İKAZ LEVHALARI



081



082



083



084



085



086



087



088



089



090



091



092



093



094

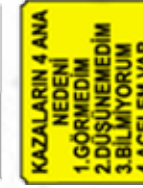

095



096



097



098



099



100



101



102

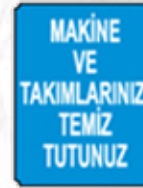

103



104

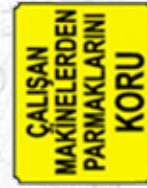

105

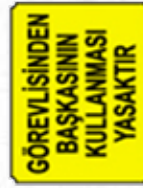

106



107



108



109



110

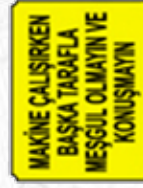

111



112



113



114



115



116



117

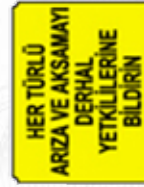

118

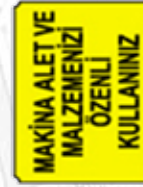

119



120





## 25 CM X 35 CM İKAZ LEVHALARI



BARETSİZ  
ÇALIŞMA

121



MAKINANIN  
ÇEVRESİNİ  
TEMİZ TUT

122



TEREDDÜTLÜ  
OLDUĞUNUZDA  
AMİRİNİZE  
BİLDİRİNİZ

123



FABRİKA TESİSLERİNE  
VE MALZEMEYE  
KENDİ MALİNİZ GİBİ  
**BAKINIZ**

124



ÇALIŞIRKEN  
KORUYUCU  
MALZEMENİ  
KULLAN

125



İŞÇİNİN  
VERİMLİSİ  
ÜRÜNÜN  
KALİTESİ

126



KARTINIZI  
BASMAI  
UNUTMAYINIZ  
BAŞKASININ  
KARTINI  
BASMAYIN

127



SOYUNMA  
DOLAPLARINDA  
DEĞERLİ EŞYA  
VE PARA  
BIRAKMAYINIZ

128



ÇALIŞANI  
MEŞGUL  
ETMEYİNİZ

129



HER VARDİYADA  
TEMİZLİK  
YAPILACAKTIR

130



FABRİKAMIZI  
TEMİZ  
TUTALIM

131



YERLERE  
SİGARA  
VE ÇÖP  
ATMAYINIZ

132



ÇEVREMİZİ  
TEMİZ  
TUTALIM

133



GARAJ KAPISI  
PARK ETMEYİNİZ

134



YABANCI ARAÇ  
PARK EDEMEZ

135



İNŞAAT ÖNÜNE  
PARK ETMEYİNİZ

136



KALİTESİZ  
ÜRETİM  
İSRAFTIR

137



İNİZAM VE  
TEMİZLİK  
Güvenliği Arttırır

138



**KÖPEK  
VAR**

139



ÜSTÜNE AIT  
OLMAYAN İŞE  
KARİŞMA

140

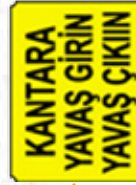

KANTARA  
YAVAŞ GİRİN  
YAVAŞ ÇIKIIN

141



İŞYERİMİZDE  
AŞGARI ÜCRET  
TLDİR

142



İLGİLİ OLMAYAN  
KİŞİLERİN  
AMBARA GİRMESİ  
YASAKTIR

143



BEKÇİYE  
MURACAAT  
EDİNİZ

144



ÇIKIŞ-EXIT

145



KORUYUCU  
MALZEME  
KULLAN

146



MUSLUKLARI  
AÇIK  
BIRAKMAYINIZ

147



ÇEVREYE  
İŞLETMEYEN  
VERİMLİLİĞİNİZ  
ZARAR VE  
RAHATSIZLIKTAN  
DOLAYI  
ÖZÜR DİLERİZ

148



**BOTAŞ ACIL**  
TEL: 187

149



**DİKKAT**  
DOĞALGAZ

150



PARK ETMEK  
YASAKTIR  
ARACINIZ  
ÇEKİLİR

151



BU İŞLETMEDE  
SİGARA İÇMEK  
YASAKTIR

152



ÇIKIŞ-EXIT

153



İŞ  
ELBİSENİ  
GIY

154



TOPLANMA  
ALANI

155



KAZAN DAİRESİNE  
YETKİLİLERDEN  
BAŞKA KİMSE  
GİREMEZ

156



İLGİLİ OLMAYAN  
KİŞİLERİN  
AMBARA GİRMESİ  
YASAKTIR

157



## Hangi Renk Ne Anlama Geliyor? / Meaning of Colors

	<b>Zorunluluk (Mandatory Sign)</b> Renk: Mavi Zemin Beyaz Yaz Mavi çember içerisinde piktoqram Uyulmas zorunlu eylemi anlatir.		<b>Güvenli Bölge ve Acil Durum (Safe Condition Sign)</b> Renk: Yeşil Zemin Beyaz Yaz Yeşil kare içerisinde piktoqram Acil durum müdahale evantreni Güvenli bölgeye ulasmaz için bilgilendirme.
	<b>Yasaklayıcı (Prohibition Sign)</b> Renk: Beyaz Zemin Kırmızı Bar Siyah Yaz Kırmızı yuvarlakta bar İçerisinde siyah piktoqram Yapılmas yasaklanıy eylemi bilgilendirme.		<b>Yangın Müdahale (Fire Equipment Sign)</b> Renk: Kırmızı Zemin Beyaz Yaz Kırmızı kare zeminde beyaz piktoqram Yangın müdahale ekipman yerlerini bilgilendirir. Kullanım yöntemlerini açıklar.
	<b>Tehlike (Hazard Sign)</b> Renk: Sarı Zemin Siyah Yaz Üçgen zemin içerisinde siyah piktoqram Tehlike durumu halinde bilgilendirme. environment.	<b>Genel Uyarılar (General Signs)</b> Renk: Değişik Güvenlik, tehlike vb. unsurları dışında ISO tanımlanmış olmayan, işaretleme ihtiyaç duyulan levhalardır.	

### 7,5 CM X 23 CM KISIM LEVHALARI

<b>GİRİŞ</b> K01	<b>ÇIKIŞ</b> K02	<b>PERSONEL KAPISI</b> K03	<b>MİSAFİRHANE</b> K04	<b>BEKLEME YERİ</b> K05	<b>ZİYARETÇİ</b> K06
<b>DİNLENME ODASI</b> K07	<b>BANYO</b> K08	<b>MÜRACAAT</b> K09	<b>GÜVENLİK</b> K10	<b>TEMİZLİK DOLABI</b> K11	<b>İDARE</b> K12
<b>İDARİ İŞLER</b> K13	<b>İDARİ BÖLÜM</b> K14	<b>MÜDÜR</b> K15	<b>KASA</b> K16	<b>VEZNE</b> K17	<b>BÜRO</b> K18
<b>SATIŞ</b> K19	<b>ŞEF</b> K20	<b>DOKTOR</b> K21	<b>GÖREVLİ</b> K22	<b>ASANSÖR</b> K23	<b>HURDA</b> K24
<b>KESİMHANE</b> K25	<b>KANTİN</b> K26	<b>BOŞ</b> K27	<b>DOLU</b> K28	<b>MUTFAK</b> K29	<b>YATAKHANE</b> K30
<b>STOK</b> K31	<b>DEPO</b> K32	<b>BEKÇİ</b> K33	<b>DİKİMHANE</b> K34	<b>KÜTÜPHANE</b> K35	<b>AMBAR</b> K36
<b>ARŞİV</b> K37	<b>ÇAY OCAĞI</b> K38	<b>İMALAT</b> K39	<b>İŞÇİ KOĞUŞU</b> K40	<b>KAZAN DAİRESİ</b> K41	<b>LABORATUAR</b> K42
<b>MONTAJ</b> K43	<b>MUHASEBE</b> K44	<b>REVİR</b> K45	<b>SOYUNMA ODALARI</b> K46	<b>TEKNİK SERVİS</b> K47	<b>TOPLANTI SALONU</b> K48
<b>YEMEKHANE</b> K49	<b>YÜK ASANSÖRÜ</b> K50	<b>W.C.</b> K51	 BAY W.C. K52	 BAYAN W.C. K53	





## Ø 30 CM ÖZEL LEVHALAR



## 50 CM X 70 CM ÖZEL LEVHALAR



## KAYGAN ZEMİN LEVHALARI



Çift Taraflı  
Double Face

Order Nr.  
Sipariş Kodu  
911137

Ebatlar / Size : 245 mm x 620 mm



Çift Taraflı  
Double Face

Order Nr.  
Sipariş Kodu  
19900

Ebatlar / Size : 280 mm x 620 mm



Order Nr.  
Sipariş Kodu  
100036

## KAYNAK PERDESİ

Açıklama Çevreyi kaynak sıçramalarından koruyan portatif kaynak perdesi  
Description : Portable welding curtain that protects against welding sparks and spatter

Ebatlar / Size : 180 cm x 130 cm

Renkler / Colors :

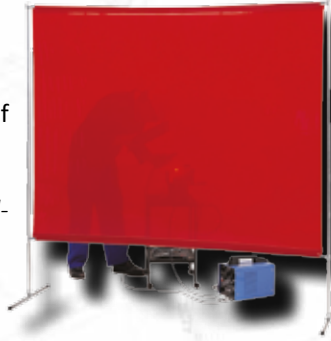

Order Nr.  
Sipariş Kodu  
999883

## KAMYON ARKASI REFLEKTÖR



Açıklama Uluslararası kamyon arkası reflektör  
Description : Rear reflector marker boards for trucks

Ebatlar / Size : 565 mm x 140 mm

## LİNEER DOĞRULAMA SİSTEMİ



Ebatlar / Size : 100 mm x 860 mm

Order Nr.  
Sipariş Kodu  
880402





**REFLEKTİF BANTLAR**



Order Nr.  
Sipariş Kodu  
**BANT 003**

**10 MM X 25 MT**



Renkler / Colors



**20 MM X 25 MT**



Renkler / Colors



Order Nr.  
Sipariş Kodu  
**BANT 004**

Order Nr.  
Sipariş Kodu  
**BANT 005**

**40 MM X 25 MT**



Renkler / Colors



**92 MM X 25 MT**



Renkler / Colors



Order Nr.  
Sipariş Kodu  
**BANT 007**

Order Nr.  
Sipariş Kodu  
**BANT 009**

**170 MM X 25 MT**



Renkler / Colors



**50 MM X 25 MT**



Renkler / Colors



Order Nr.  
Sipariş Kodu  
**BANT 010**

Order Nr.  
Sipariş Kodu  
**BANT 011**

**92 MM X 25 MT**



Renkler / Colors



**170 MM X 25 MT**



Renkler / Colors

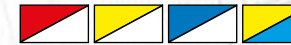

Order Nr.  
Sipariş Kodu  
**BANT 012**

Order Nr.  
Sipariş Kodu  
**202327**



96

## YER İŞARETLEME BANTLARI

Açıklama Endüstriyel alanlar için güçlü yapışkanlı yer işaretleme bantları  
Description : Heavy duty floor marking tape coated with aggressive adhesive

Yapışkanlı / Adhesive : ✓

Reflektörlü / Reflective : ✗

Ebatlar / Size : 50 mm x 46 mt



Order Nr.  
Sipariş Kodu  
**202334**

## KAYDIRMAZ BANTLAR

Açıklama Kaygan zeminler için kaydırmaz bant  
Description : Anti-slip abrasive floor tape for areas that get wet or otherwise contaminated

Yapışkanlı / Adhesive : ✓

031019

50 MM X 45 MT



12



50 MM X 45 MT

031026

031088

25 MM X 45 MT



24



25 MM X 45 MT

031057

031101

50 MM X 10 MT



25



50 MM X 10 MT

031071

031095

25 MM X 10 MT



50



25 MM X 10 MT

031064





Order Nr.  
Sipariş Kodu  
KIM0002

## YAĞ EMİCİ PED



**Açıklama** Yağ emici pedler rulo veya parçalı halde satın alınabilir.  
**Description :** Pedler suyu emmeden sadece yağı emecektir  
*Oil only absorbent pads and rolls are specialized for absorption of hydraulic oil, motor oil, brake fluid, cooking oil, turpentine and many more oil-based fluids*

100

**Ağırlık / Weight :** 350 gr/m<sup>2</sup>

**Kapasite / Capacity :** 109 lt (ped / pad), 96 lt (rulo / roll)

**Ebatlar** 50 cm x 50 cm (ped / pad),  
**Size :** 38 cm x 46 mt (rulo / roll)

**Renkler / Colors :**



## YAĞ EMİCİ SOSİS

Order Nr.  
Sipariş Kodu  
KIM0003

**Açıklama** Yağ emici sosis çalışma alanındaki tüm  
**Description :** sıvıyı emecektir  
*Absorbent socks are specialized for absorption of all liquids on your work place*

**Renkler / Colors :**



Ağırlık / Weight	Ebatlar / Size	Kapasite / Capacity	
350 gr	8 cm x 120 cm	53 lt	20
800 gr	8 cm x 300 cm	42 lt	7
2.750 gr	13 cm x 300 cm	103 lt	5



## YAĞ EMİCİ YASTIK

Order Nr.  
Sipariş Kodu  
KIM0006



Açıklama / Description : Yağ emici yastık çalışma alanındaki tüm sıvıyı emecektir.  
Absorbent pillows are specialized for absorption of all liquids on your work place

Renkler / Colors :

Ağırlık / Weight	Ebatlar / Size	Kapasite / Capacity	
160 gr	23 cm x 23 cm	24 lt	20
650 gr	45 cm x 45 cm	49 lt	10



Order Nr.  
Sipariş Kodu  
KIM0004

## YAĞ EMİCİ SET

Açıklama / Description : Seyyar yağ emici konteyner set  
Complete spill kit in a mobile wheeled bin

Kapasite / Capacity : 110 lt

Ebatlar / Size : 62 cm x 52 cm x 100 cm



### İçindekiler / Contents

- Yağ emici sosis
- Yağ emici yastık
- Yağ emici ped
- Koruyucu gözlük
- Kimyasal eldiven
- Atık poşeti
- Bağcık
- Absorbent socks
- Absorbent pillow
- Absorbent pad
- Chemical goggle
- Chemical glove
- Waste bag
- Barrier tape





**TRAFİK**  
**EKİPMANLARI**  
ROAD SAFETY

▶ Trafik Koniler  
*Traffic Cones*

▶ Duba ve Dikmeler  
*Warning Posts and Barriers*

▶ Bariyerler  
*Barriers*

▶ Yol Butonları ve Hız Kesiciler  
*Road Markers and Speed Bumps*

▶ Zemin İşaretlemeleeri  
*Floor Markings*

▶ Flaşör Uyarı Lambaları  
*Flasher Lamps*

▶ Ledli Levhalar  
*Led Displays*

▶ Diğer Trafik Ekipmanları  
*Other Equipments*

## Trafik Konileri Traffic Cones



### MİNİ TRAFİK KONİSİ

Order Nr.  
Sipariş Kodu  
**12303**

Malzeme / Material : PVC

Ağırlık / Weight : 0,65 kg

Yükseklik / Size : 32 cm

Reflektör / Reflective : ✓

Aksesuar uyumlu / Accesories attachable : ✓

Standart / Certification : EN 13422+A1

Order Nr.  
Sipariş Kodu  
**12302**

### EKO TRAFİK KONİSİ

Malzeme / Material : PPC

Ağırlık / Weight : 0,85 kg

Yükseklik / Size : 50 cm

Reflektör / Reflective : ✗

Aksesuar uyumlu / Accesories attachable : ✗



### STANDART TRAFİK KONİSİ

Order Nr.  
Sipariş Kodu  
**210308**

Malzeme / Material : PVC

Ağırlık / Weight : 0,90 kg

Yükseklik / Size : 50 cm

Reflektör / Reflective : ✗

Aksesuar uyumlu / Accesories attachable : ✗



## Trafik Konileri Traffic Cones

### KEDİ GÖZLÜ TRAFİK KONİSİ

Malzeme / Material : PPC

Ağırlık 1,15 kg (200903)

Weight : 4,00 kg (200811)

Yükseklik 50 cm (200903)

Size : 52 cm (200811)

Kedi gözü / Cat eyes : ✓

Aksesuar uyumlu

Accessories attachable : ✓

Order Nr.  
Sipariş Kodu  
**200811**

Order Nr.  
Sipariş Kodu  
**200903**



### ULTRA KEDİ GÖZLÜ TRAFİK KONİSİ

Malzeme / Material : PPC

Ağırlık 1,50 kg (12350)

Weight : 5,15 kg (12351)

Yükseklik 60 cm (12350)

Size : 62 cm (12351)

Kedi gözü / Cat eyes : ✓

Aksesuar uyumlu / Accessories attachable : ✓

Renkler / Colors : 

Order Nr.  
Sipariş Kodu  
**12350**

Order Nr.  
Sipariş Kodu  
**12351**



Order Nr.  
Sipariş Kodu  
**12352**

Trafik Konileri *Traffic Cones*



Order Nr.  
Sipariş Kodu  
**12314**



Order Nr.  
Sipariş Kodu  
**12316**

**PVC TRAFİK KONİSİ**

Malzeme / Material : PVC

Ağırlık / Weight : 1,70 kg

Yükseklik / Size : 50 cm

Reflektör / Reflective :  (12316)  
 (12314)

Aksesuar uyumlu  
Accessories attachable :

Standart / Certification : EN 13422+A1

**PVC TRAFİK KONİSİ**

Malzeme / Material : PVC

Ağırlık / Weight : 1,30 kg (12304-12306)  
2,65 kg (12326)

Yükseklik / Size : 50 cm

Reflektör / Reflective :  (12304)  
 (12306-12326)

Aksesuar uyumlu  
Accessories attachable :

Standart / Certification : EN 13422+A1



Order Nr.  
Sipariş Kodu  
**12326**

Order Nr.  
Sipariş Kodu  
**12306**



Order Nr.  
Sipariş Kodu  
**12304**





## Trafik Konileri Traffic Cones



### PVC TRAFİK KONİSİ

Malzeme / Material : PVC

Ağırlık / Weight : 1,25 kg

Yükseklik / Size : 52 cm

Reflektör / Reflective : **X** (12328)  
**✓** (12330-12332)

Aksesuar uyumlu  
Accessories attachable : **✓**

Standart / Certification : EN 13422+A1

Order Nr.  
Sipariş Kodu  
**12328**

Order Nr.  
Sipariş Kodu  
**12330**

Order Nr.  
Sipariş Kodu  
**12332**

### EKO TRAFİK KONİSİ

Malzeme / Material : PPC

Ağırlık / Weight : 2,20 kg (12322)  
4,90 kg (12320)

Yükseklik / Size : 75 cm

Reflektör / Reflective : **✓**

Aksesuar uyumlu  
Accessories attachable : **X**

Order Nr.  
Sipariş Kodu  
**12320**

Order Nr.  
Sipariş Kodu  
**12322**

## Trafik Konileri Traffic Cones

### PVC TRAFİK KONİSİ

Malzeme / Material : PVC

Ağırlık / Weight : 2,30 kg

Yükseklik / Size : 70 cm

Reflektör / Reflective :  (12333)  
 (12335-12337)

Aksesuar uyumlu  
Accessories attachable :

Standart / Certification : EN 13422+A1



Order Nr.  
Sipariş Kodu  
12337



Order Nr.  
Sipariş Kodu  
12335



Order Nr.  
Sipariş Kodu  
12333



### PVC TRAFİK KONİSİ

Malzeme / Material : PVC

Ağırlık / Weight : 3,20 kg

Yükseklik / Size : 75 cm

Reflektör / Reflective :  (12305)  
 (12307)

Aksesuar uyumlu  
Accessories attachable :

Standart / Certification : EN 13422+A1

Order Nr.  
Sipariş Kodu  
12307



Order Nr.  
Sipariş Kodu  
12305





## Trafik Konileri Traffic Cones

### PVC TRAFİK KONİSİ

Malzeme / Material : PVC

Ağırlık / Weight : 3,20 kg (12309)  
6,50 kg (12315)

Yükseklik / Size : 75 cm

Reflektör / Reflective : ✓

Aksesuar uyumlu

Accessories attachable : ✓

Standart / Certification : EN 13422+A1



Esnek  
Flexible

Order Nr.  
Sipariş Kodu  
12315

Order Nr.  
Sipariş Kodu  
12309



### PVC TRAFİK KONİSİ

Malzeme / Material : PVC

Ağırlık / Weight : 3,60 kg (12321-12325)  
6,90 kg (12327)

Yükseklik / Size : 90 cm

Reflektör / Reflective : ✗ (12321)  
✓ (12325-12327)

Aksesuar uyumlu

Accessories attachable : ✓

Standart / Certification : EN 13422+A1



Esnek  
Flexible

Order Nr.  
Sipariş Kodu  
12321

Order Nr.  
Sipariş Kodu  
12325

Order Nr.  
Sipariş Kodu  
12327



## Trafik Konileri *Traffic Cones*

### LEVHALI ULTRA KEDİ GÖZLÜ KONİ

Malzeme / Material : PPC

Ağırlık / Weight : 5,35 kg - 5,60 kg

Yükseklik / Size : 110 cm

Kedi gözü / Cat eyes : ✓

Renkler / Colors : 

Order Nr.  
Sipariş Kodu  
**12612**



Order Nr.  
Sipariş Kodu  
**12614**



Order Nr.  
Sipariş Kodu  
**201511**

### LEVHALI KEDİ GÖZLÜ KONİ

Malzeme / Material : PPC

Ağırlık / Weight : 4,30 kg - 4,70 kg

Yükseklik / Size : 87 cm - 100 cm

Kedi gözü / Cat eyes : ✓





## Duba ve Dikmeler *Warning Posts and Barriers*

### DUBALI UYARI DİKMESİ

Ø 63 mm

Malzeme / Material : PP

Ağırlık / Weight : 4,00 kg

Yükseklik / Size : 100 cm

Reflektör / Reflective :  (12403)  
 (270012)

Aksesuar uyumlu  
Accessories attachable :

Renkler / Colors : 

Order Nr.  
Sipariş Kodu  
**12403**

Order Nr.  
Sipariş Kodu  
**270012**



Ø 80 mm

### DUBALI UYARI DİKMESİ

Malzeme / Material : PP

Ağırlık / Weight : 6,50 kg

Yükseklik / Size : 110 cm

Reflektör / Reflective :  (12420)  
 (12418)

Aksesuar uyumlu  
Accessories attachable :

Renkler / Colors : 

Order Nr.  
Sipariş Kodu  
**12418**

Order Nr.  
Sipariş Kodu  
**12420**



Duba ve Dikmeler *Warning Posts and Barriers*

KATLANIR UYARI DUBASI

Order Nr.  
Sipariş Kodu  
**12416**



Katlanır Dizayn  
Folding Design

Order Nr.  
Sipariş Kodu  
**12415**



Malzeme / Material : PPC

Ağırlık / Weight : 6,50 kg (12416)  
11,10 kg (12415)

Yükseklik / Size : 70 cm (12416)  
100 cm (12415)

Reflektör / Reflective : ✓

Standart / Certification : EN 13422+A1



A



B



C



D



E

Order Nr.  
Sipariş Kodu  
**240206**

DUBALI UYARI DİKMESİ

Malzeme / Material : PPC

Ağırlık / Weight : 12,00 kg

Yükseklik / Size : 120 cm

Reflektör / Reflective : ✓

Aksesuar uyumlu

Accessories attachable : ✓

Renkler / Colors : 

Ø 110 mm





## Duba ve Dikmeler Warning Posts and Barriers

Order Nr.  
Sipariş Kodu  
**12503**

### KATLANIR UYARI DUBASI

Katlanır Dizayn  
Folding Design

Malzeme / Material : PPC  
Ağırlık / Weight : 15,50 kg  
Yükseklik / Size : 110 cm  
Reflektör / Reflective : ✓  
Aksesuar uyumlu  
Accessories attachable : ✓



A



B



C



D



E



### REFÜJ BAŞI DUBASI

Malzeme / Material : TPU  
Ağırlık / Weight : 1,40 kg (12253)  
2,00 kg (12254)  
3,25 kg (12250)  
Yükseklik / Size : 80 cm (12253)  
90 cm (12254)  
100 cm (12250)  
Reflektör / Reflective : ✓  
Standart / Certification : EN 13422+A1



Order Nr.  
Sipariş Kodu  
**12250**

Ø 30 CM



Order Nr.  
Sipariş Kodu  
**12254**

Ø 20 CM



Order Nr.  
Sipariş Kodu  
**12253**

Ø 10 CM

Yere Monte  
Floor Mounted  
Esnek  
Flexible



A



B



C



D



E

Duba ve Dikmeler *Warning Posts and Barriers*

**YÖN AYIRICI DELİNEATOR**

Malzeme / Material : TPU

Ağırlık / Weight : 0,95 kg (12258)  
1,40 kg (12256)

Yükseklik / Size : 50 cm (12258)  
80 cm (12256)

Reflektör / Reflective : ✓

Standart / Certification : EN 13422+A1



Esnek  
Flexible



Yere Monte  
Floor Mounted

Order Nr.  
Sipariş Kodu  
**12256**

Order Nr.  
Sipariş Kodu  
**12258**



**A**



**B**



**ŞERİT AYIRICI DELİNEATOR**

Order Nr.  
Sipariş Kodu  
**12211**

Order Nr.  
Sipariş Kodu  
**12212**

Order Nr.  
Sipariş Kodu  
**12214**

Order Nr.  
Sipariş Kodu  
**12215**



Yere Monte  
Floor Mounted



Esnek  
Flexible

Ø 80 mm

Malzeme / Material : TPU

Ağırlık / Weight : 0,72 kg (12215)  
0,98 kg (12214)  
1,30 kg (12212)  
1,60 kg (12211)

Yükseklik / Size : 30 cm (12215)  
45 cm (12214)  
75 cm (12212)  
100 cm (12211)

Reflektör / Reflective : ✓

Aksesuar uyumlu

Accessories attachable : ✓

Renkler / Colors :

Standart / Certification : EN 13422+A1





## Duba ve Dikmeler *Warning Posts and Barriers*

Yere Monte  
Floor Mounted



### REFÜJ AYIRICI DUBA

Order Nr.  
Sipariş Kodu  
**12205**

Malzeme / Material : PE

Ağırlık / Weight : 1,48 kg

Yükseklik / Size : 50 cm

Reflektör / Reflective : ✓

Aksesuar uyumlu  
Accessories attachable : ✗

Renkler / Colors :



### REFÜJ AYIRICI DUBA

Malzeme / Material : PPC

Ağırlık / Weight : 0,89 kg (12223)  
1,24 kg (12213)

Yükseklik / Size : 50 cm (12223)  
80 cm (12213)

Reflektör / Reflective : ✓

Aksesuar uyumlu  
Accessories attachable : ✗

Renkler / Colors :



Yere Monte  
Floor Mounted

Order Nr.  
Sipariş Kodu  
**12213**

Order Nr.  
Sipariş Kodu  
**12223**



Bariyerler *Barriers*

Order Nr.  
Sipariş Kodu  
**12405**

**DUBALI BARIYER**

Malzeme / Material : PPC & PVC  
Ağırlık / Weight : 31,00 kg  
Ebatlar / Size : 180cm x (h) 120 cm  
Reflektör / Reflective : ✓  
Aksesuar uyumlu  
Accessories attachable : ✓  
Renkler / Colors : 

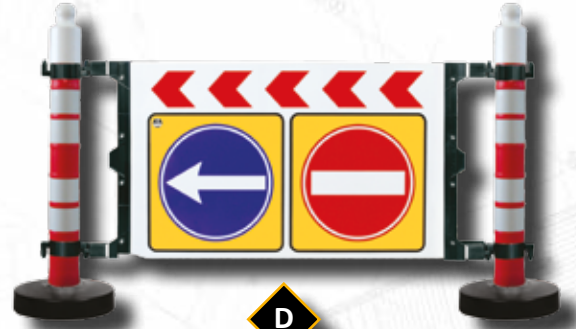

A

B

C

D



**DUBALI BARIYER**

Order Nr.  
Sipariş Kodu  
**12407**

Malzeme / Material : PPC & PVC  
Ağırlık / Weight : 27,00 kg  
Ebatlar / Size : 180cm x (h) 120 cm  
Reflektör / Reflective : ✓  
Aksesuar uyumlu  
Accessories attachable : ✓  
Renkler / Colors : 



D

C

B

A





Order Nr.  
Sipariş Kodu  
**12501**

### KATLANIR BARIYER

Malzeme / Material : PPC & PVC

Ağırlık / Weight : 20,00 kg

Ebatlar / Size : 100 cm x (h) 90 cm

Reflektör / Reflective : ✓

Aksesuar uyumlu

Accesories attachable : ✓

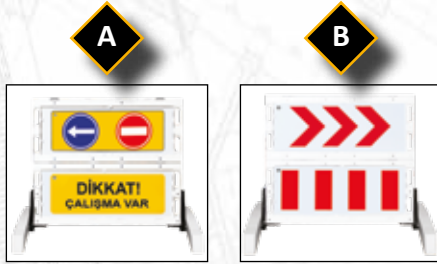

Katlanır Dizayn  
Folding Design



### KATLANIR BARIYER

Order Nr.  
Sipariş Kodu  
**12500**

Malzeme / Material : PPC & PVC

Ağırlık / Weight : 18,00 kg

Ebatlar / Size : 90 cm x (h) 150 cm

Reflektör / Reflective : ✓

Aksesuar uyumlu / Accesories attachable : ✓

Katlanır Dizayn  
Folding Design



A B C D E F G H J K

Bariyerler *Barriers*



*Katlanır Dizayn  
Folding Design*

**KATLANIR BARIYER**

Order Nr.  
Sipariş Kodu  
**12417**

Malzeme / Material : PPC

Ağırlık / Weight : 12 ,00 kg

Ebatlar / Size : 48 cm x 60 cm (h) 90 cm

Reflektör / Reflective : ✓

Aksesuar uyumlu / Accesories attachable : ✓



Order Nr.  
Sipariş Kodu  
**12504**

**KATLANIR BARIYER**

*Katlanır Dizayn  
Folding Design*

Malzeme / Material : PPC & PVC

Ağırlık / Weight : 20,00 kg

Ebatlar / Size : 236 cm x (h) 110 cm

Reflektör / Reflective : ✓

Aksesuar uyumlu  
Accesories attachable : ✓





### OTOYOL BARIYERİ

Order Nr.  
Sipariş Kodu  
**210704**

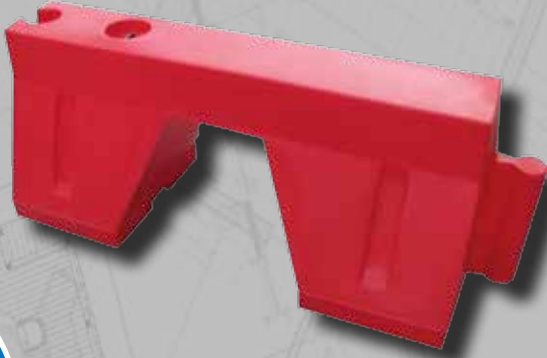

Malzeme / Material : PVC

Ağırlık / Weight : Ayarlanabilir / Adjustable

Ebatlar / Size : 120 cm x (h) 50 cm

Reflektör / Reflective : ✗

Aksesuar uyumlu  
Accessories attachable : ✗

Renkler / Colors : 

Order Nr.  
Sipariş Kodu  
**12510**

### GÜVENLİK BARIKATI

Malzeme / Material : PPC & PVC

Ağırlık / Weight : 12,30 kg

Ebatlar / Size : 150 cm x (h) 100 cm

Reflektör / Reflective : ✓

Aksesuar uyumlu  
Accessories attachable : ✓

Renkler / Colors : 



B

C

D

E

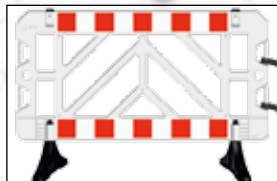
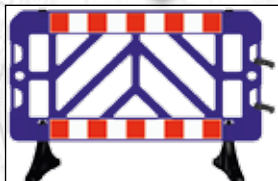
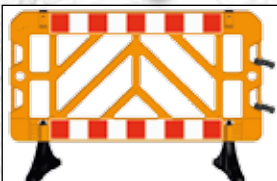

## Bariyerler *Barriers*

Order Nr.  
Sipariş Kodu  
**218601**

### ŞERİTLİ İÇ MEKAN BARIYERİ

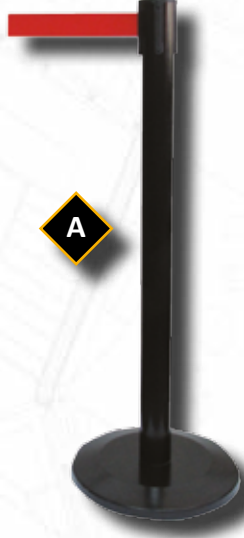

Duvar-Tipi  
Wall Mounted



Koni Mekanizması  
For Traffic Cones



Malzeme / Material : Metal

Ağırlık / Weight : 12,00 kg

Yükseklik / Size : 95 cm

Şerit uzunluğu / Strip length : 2,30 mt

Şerit renkleri / Strip colors :

Renkler / Colors :



### AKERDEON TİP BARIYER

Order Nr.  
Sipariş Kodu  
**125015**

Malzeme / Material : PVC

Ağırlık / Weight : 6,80 kg

Ebatlar / Size : 250 cm x (h) 94 cm

Reflektör / Reflective :

Aksesuar uyumlu

Accessories attachable :

Renkler / Colors :





Order Nr.  
Sipariş Kodu  
12365

### OTOPARK DİKMESİ

Ø 110 mm

Malzeme / Material : PPC

Ağırlık / Weight : 12,00 kg

Yükseklik / Size : 80 cm

Reflektör / Reflective : ❌

Aksesuar uyumlu

Accessories attachable : ✅

Renkler / Colors : 



### OTOPARK BARIYERİ

Malzeme / Material : Metal

Yükseklik / Size : 50 cm (210023)  
90 cm (219000)

Reflektör / Reflective : ✅

Renkler / Colors : 



Yere Monte  
Floor Mounted



Order Nr.  
Sipariş Kodu  
210023



Order Nr.  
Sipariş Kodu  
219000



Yol Butonları ve Hız Kesiciler *Road Markers and Speed Bumps*

Order Nr.  
Sipariş Kodu  
**12011**

**ANKARAJLI YOL BUTONU**

  
**Yere Monte**  
Floor Mounted



Malzeme / Material : Alüminyum / Aluminium  
Ağırlık / Weight : 0,375 kg  
Ebatlar / Size : 100 mm x 100 mm x (h) 21 mm  
Kedi gözü / Cat eyes : 

**METAL YOL BUTONU**

Order Nr.  
Sipariş Kodu  
**200701**

  
**Yere Monte**  
Floor Mounted



Malzeme / Material : Alüminyum / Aluminium  
Ağırlık / Weight : 0,290 kg  
Ebatlar / Size : 120 mm x 120 mm x (h) 28 mm  
Kedi gözü / Cat eyes : 

Order Nr.  
Sipariş Kodu  
**12009**

**ABS YOL BUTONU**

  
**Yere Monte**  
Floor Mounted



Malzeme / Material : ABS  
Ağırlık / Weight : 0,150 kg  
Ebatlar / Size : 100 mm x 100 mm x (h) 21 mm  
Kedi gözü / Cat eyes : 

**OTOYOL BUTONU**

Order Nr.  
Sipariş Kodu  
**200514**

  
**Yere Monte**  
Floor Mounted



Malzeme / Material : ABS  
Ağırlık / Weight : 0,110 kg  
Ebatlar / Size : 105 mm x 105 mm x (h) 20 mm  
Reflektör / Reflective : 





## Yol Butonları ve Hız Kesiciler *Road Markers and Speed Bumps*

Order Nr.  
Sipariş Kodu  
**220000**

### KLASİK YOL BUTONU

  
Yere Monte  
Floor Mounted



Malzeme / Material : PPC  
Ağırlık / Weight : 0,190 kg  
Ebatlar / Size : 125 mm x 150 mm x (h) 32 mm  
Reflektör / Reflective : ✓

### KARE YOL BUTONU

Order Nr.  
Sipariş Kodu  
**200200**

  
Yere Monte  
Floor Mounted



Malzeme / Material : PPC  
Ağırlık / Weight : 0,170 kg  
Ebatlar / Size : 120 mm x 120 mm x (h) 28 mm  
Reflektör / Reflective : ✓

Order Nr.  
Sipariş Kodu  
**200606**

### OVAL YOL BUTONU

  
Yere Monte  
Floor Mounted



Malzeme / Material : PPC  
Ağırlık / Weight : 0,150 kg  
Ebatlar / Size : 120 mm x 220 mm x (h) 28 mm  
Reflektör / Reflective : ✓

### UFO YOL BUTONU

Order Nr.  
Sipariş Kodu  
**200415**

  
Yere Monte  
Floor Mounted



Malzeme / Material : PPC  
Ağırlık / Weight : 0,120 kg  
Ebatlar / Size : 120 mm x 140 mm x (h) 25 mm  
Reflektör / Reflective : ✓

Yol Butonları ve Hız Kesiciler Road Markers and Speed Bumps

Order Nr.  
Sipariş Kodu  
200309

SET YOL BUTONU

  
Yere Monte  
Floor Mounted



Malzeme / Material : PPC  
Ağırlık / Weight : 0,240 kg  
Ebatlar / Size : 100 mm x 220 mm x (h) 32 mm  
Reflektör / Reflective : 





SOLAR YOL BUTONU

Order Nr.  
Sipariş Kodu  
11924



  
Yere Monte  
Floor Mounted

Malzeme / Material : Alüminyum / Aluminium  
Ağırlık / Weight : 0,480 kg  
Ebatlar / Size : 125 mm x 145 mm x (h) 28 mm  
Led ışıklar / Led lights :   
Led renkleri / Led colors : 

Order Nr.  
Sipariş Kodu  
11922

SOLAR YOL BUTONU



  
Yere Monte  
Floor Mounted



Malzeme / Material : Alüminyum / Aluminium  
Ağırlık / Weight : 0,450 kg  
Ebatlar / Size : 125 mm x 145 mm x (h) 28 mm  
Led ışıklar / Led lights :   
Led renkleri / Led colors : 



SOLAR YOL BUTONU

Order Nr.  
Sipariş Kodu  
11921



  
Yere Monte  
Floor Mounted

Malzeme / Material : Alüminyum / Aluminium  
Ağırlık / Weight : 0,575 kg  
Ebatlar / Size : 125 mm x 135 mm x (h) 28 mm  
Led ışıklar / Led lights :   
Led renkleri / Led colors : 





## Yol Butonları ve Hız Kesiciler *Road Markers and Speed Bumps*

Order Nr.  
Sipariş Kodu  
**12268**

### ŞERİT DÜZENLEME BUTONU

Malzeme / Material : PPC & TPU  
Ağırlık / Weight : 4,25 kg  
Ebatlar / Size : 100 cm x 220 cm x (h) 75 cm  
Reflektör / Reflective : ✓  
Aksesuar uyumlu  
Accessories attachable : ✓

  
Yere Monte  
Floor Mounted

  
Esnek  
Flexiable

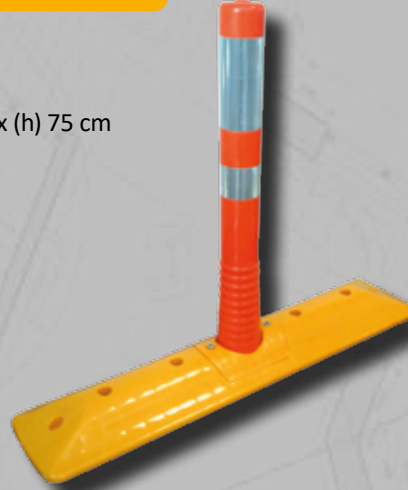

  
Esnek  
Flexible

  
Yere Monte  
Floor Mounted

### ŞERİT DÜZENLEME BUTONU

Malzeme / Material : PPC & TPU  
Ağırlık / Weight : 4,15 kg (12218)  
4,50 kg (12219)  
Ebatlar / Size : 100 cm x 200 cm x (h) 45 cm (12218)  
100 cm x 200 cm x (h) 75 cm (12219)  
Reflektör / Reflective : ✓  
Aksesuar uyumlu  
Accessories attachable : ✓

Order Nr.  
Sipariş Kodu  
**12218**

Order Nr.  
Sipariş Kodu  
**12219**

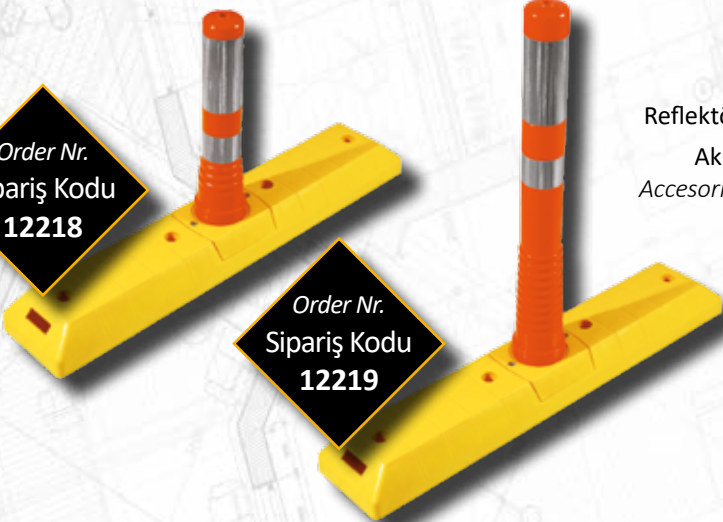

Yol Butonları ve Hız Kesiciler Road Markers and Speed Bumps

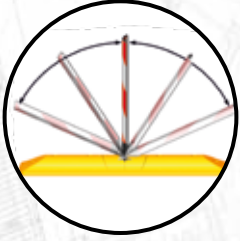

ŞERİT DÜZENLEME BUTONU

Malzeme / Material : PPC & PE

Ağırlık / Weight : 3,60 kg

Ebatlar / Size : 100 cm x 220 cm x (h) 65 cm

Reflektör / Reflective : ✓

Aksesuar uyumlu / Accesories attachable : ✗

Order Nr.  
Sipariş Kodu  
12266UBR

Yere Monte  
Floor Mounted

Esnek  
Flexible



A



B



C



D



E

ARAÇ STOPERLERİ

Order Nr.  
Sipariş Kodu  
12216

55 cm

Yere Monte  
Floor Mounted

Order Nr.  
Sipariş Kodu  
12231

180 cm

Order Nr.  
Sipariş Kodu  
12235

55 cm

Order Nr.  
Sipariş Kodu  
12233

110 cm



## Yol Butonları ve Hız Kesiciler *Road Markers and Speed Bumps*



  
**Yere Monte**  
Floor Mounted

  
**Esnek**  
Flexible

### ŞERİT DÜZENLEME BUTONU

Malzeme / Material : PPC & TPU (12209)  
PPC & PE

Ağırlık / Weight : 0,75 kg (12209,12207)  
0,90 kg (12206)  
2,30 kg (12202)  
2,50 kg (12203)  
2,70 KG (12204)

Ebatlar / Size : 26 cm x 16 cm x (h) 30 cm (12209)  
26 cm x 16 cm x (h) 28 cm (12207)  
26 cm x 16 cm x (h) 60 cm (12206)  
120 cm x 15 cm x (h) 28 cm (12203)  
120 cm x 15 cm x (h) 60 cm (12204)  
120 cm x 15 cm x (h) 5 cm (12202)

Reflektör / Reflective : 



Order Nr.  
Sipariş Kodu  
**12207**



Order Nr.  
Sipariş Kodu  
**12206**



Order Nr.  
Sipariş Kodu  
**12209**



Order Nr.  
Sipariş Kodu  
**12204**



Order Nr.  
Sipariş Kodu  
**12203**



Order Nr.  
Sipariş Kodu  
**12202**

Yol Butonları ve Hız Kesiciler *Road Markers and Speed Bumps*

Order Nr.  
Sipariş Kodu  
12290

OTOPARK KASİS KAPANI



Yere Monte  
Floor Mounted

YAN KAPAK

Order Nr.  
Sipariş Kodu  
12291

Malzeme / Material : PPC & Metal

Ağırlık / Weight : 7,30 kg (12290)  
0,70 kg (12291)

Ebatlar / Size : 50 cm x 50 cm x (h) 6 cm (12290)  
50 cm x 9 cm x (h) 6 cm (12291)

Reflektör / Reflective : ✓

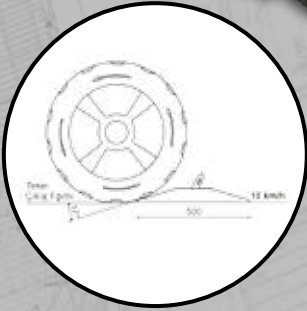

KABLO KORUYUCU KASİS

Order Nr.  
Sipariş Kodu  
12298

Malzeme / Material : PPC & PVC

Ağırlık / Weight : 8,70 kg

Ebatlar / Size : 60 cm x 50 cm x (h) 7,5 cm

Kablo yuvası / Cable line : 3 x Ø 50 mm

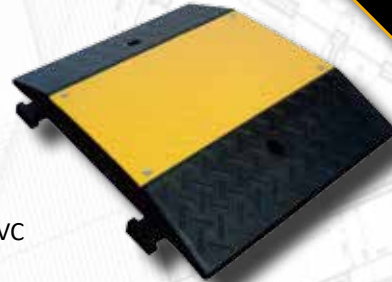



## Yol Butonları ve Hız Kesiciler Road Markers and Speed Bumps



Yere Monte  
Floor Mounted

### KAUÇUK ŞASELİ YOL KASISI

Order Nr.  
Sipariş Kodu  
12110

Order Nr.  
Sipariş Kodu  
12111

### YAN KAPAK

Malzeme / Material : PVC Compound

Ağırlık / Weight : 6,50 kg (12110)  
1,65 kg (12111)

Ebatlar / Size : 40 cm x 50 cm x (h) 4 cm (12110)  
40 cm x 20 cm x (h) 4 cm (12111)

Reflektör / Reflective : ✓

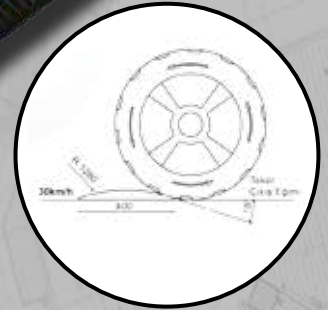
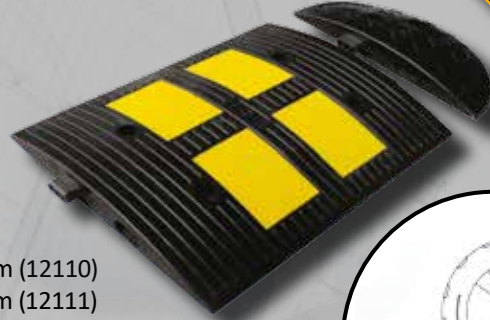

Order Nr.  
Sipariş Kodu  
12104

### KAUÇUK ŞASELİ YOL KASISI

Yere Monte  
Floor Mounted

### YAN KAPAK

Order Nr.  
Sipariş Kodu  
12105

Malzeme / Material : PVC Compound

Ağırlık / Weight : 6,25 kg (12104)  
3,00 kg (12105)

Ebatlar / Size : 50 cm x 33 cm x (h) 4,5 cm (12104)  
50 cm x 25 cm x (h) 4,5 cm (12105)

Reflektör / Reflective : ✓



## Yol Butonları ve Hız Kesiciler *Road Markers and Speed Bumps*

Order Nr.  
Sipariş Kodu  
**12108**

### KAUÇUK ŞASELİ YOL KASISI



Yere Monte  
Floor Mounted

### YAN KAPAK

Order Nr.  
Sipariş Kodu  
**12109**

Malzeme / Material : PVC Compound

Ağırlık / Weight : 9,32 kg (12108)  
3,40 kg (12109)

Ebatlar / Size : 60 cm x 50 cm x (h) 4,5 cm (12108)  
60 cm x 30 cm x (h) 4,5 cm (12109)

Reflektör / Reflective : ✓

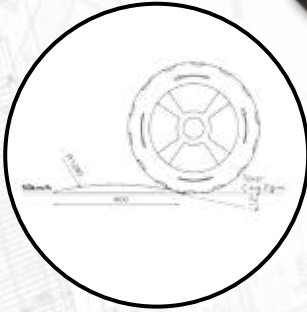

Order Nr.  
Sipariş Kodu  
**12107**

### YAN KAPAK

Yere Monte  
Floor Mounted

### KAUÇUK ŞASELİ YOL KASISI

Order Nr.  
Sipariş Kodu  
**12106**

Malzeme / Material : PVC Compound

Ağırlık / Weight : 6,50 kg (12106)  
1,65 kg (12107)

Ebatlar / Size : 40 cm x 50 cm x (h) 4 cm (12106)  
40 cm x 20 cm x (h) 4 cm (12107)

Reflektör / Reflective : ✓

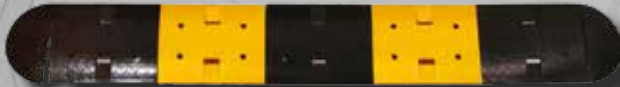



## Yol Butonları ve Hız Kesiciler *Road Markers and Speed Bumps*

Order Nr.  
Sipariş Kodu  
**11938**

### FLAŞÖRLÜ YOL KASISI



  
**Yere Monte**  
Floor Mounted



### YAN KAPAK

Order Nr.  
Sipariş Kodu  
**11940**

Malzeme / Material : PPC & PC

Ağırlık / Weight : 3,13 kg (11938)  
1,10 kg (11940)

Ebatlar / Size : 50 cm x 50 cm x (h) 4,5 cm (11938)  
50 cm x 25 cm x (h) 4,5 cm (11940)

Led ışıklar / Led lights : 

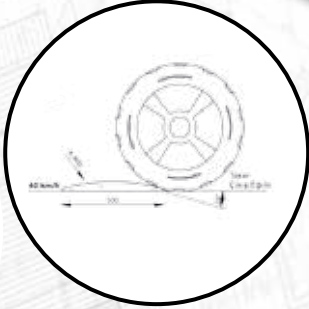

  
**Yere Monte**  
Floor Mounted

### OVAL YOL KASISI

Order Nr.  
Sipariş Kodu  
**12102**

Order Nr.  
Sipariş Kodu  
**12103**

### YAN KAPAK

Malzeme / Material : PPC

Ağırlık / Weight : 1,33 kg (12102)  
0,25 kg (12103)

Ebatlar / Size : 30 cm x 33 cm x (h) 4 cm (12102)  
30 cm x 10 cm x (h) 4 cm (12103)

Reflektör / Reflective : 



## Zemin İşaretlemeleri *Floor Markings*

### GÖRME ENGELLİ HİSSEDİLEBİLİR ZEMİN

Malzeme / Material : TPU

Ebatlar / Size : 40 cm x 40 cm

Uygulama / Application : Epoksi / Epoxy

Order Nr.  
Sipariş Kodu  
**PL8010**



Order Nr.  
Sipariş Kodu  
**PL8012**

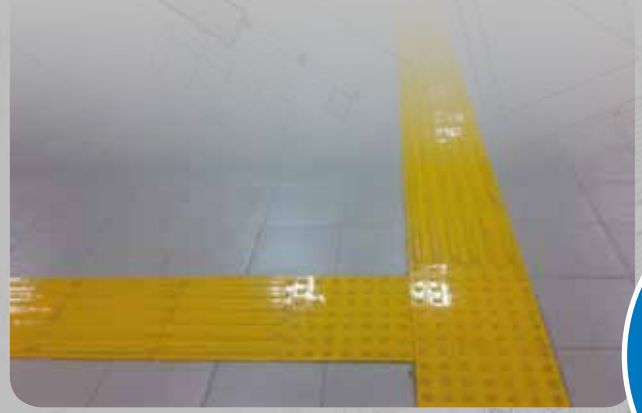

### ZEMİN UYARILARI

Uygulama / Application : Kendinden yapışkanlı / Self adhesive

Order Nr.  
Sipariş Kodu  
**PL5012**



1 mt



2 mt

**PL5014**



1,2 mt

**PL5015**

**PL5016**



2 mt

**PL5017**

**PL5018**



## Flaşör Uyarı Lambaları ve Ledli Levhalar *Flasher Lamps & Led Displays*

### SOLAR FLAŞÖRLÜ UYARI LAMBALARI



Malzeme / Material : PA & PC

Ağırlık / Weight : 0,35 kg

Ebatlar / Size : (Ø) 13 cm x (h) 15 cm

Led sayısı / Led number : 6

Renkler / Colors :



### VİDALI AKSESUAR APARATLARI

#### KONİ APARATI

126A



#### DELİNEATOR APARATI

194A



#### ZİNCİR HALKASI

174A



**Flaşör Uyarı Lambaları ve Ledli Levhalar** *Flasher Lamps & Led Displays*

**SOLAR FLAŞÖRLÜ UYARI LAMBALARI**



Malzeme / Material : ABS & PC

Ağırlık / Weight : 0,84 kg

Ebatlar / Size : 9 cm x 24 cm x (h) 29 cm

Led sayısı / Led number : 4 + 4

Renkler / Colors : 



Order Nr.  
Sipariş Kodu  
**11811**

Order Nr.  
Sipariş Kodu  
**11813**



**SOLAR FLAŞÖRLÜ UYARI LAMBALARI**



Malzeme / Material : ABS & PC

Ağırlık / Weight : 0,75 kg

Ebatlar / Size : 9 cm x 22 cm x (h) 29 cm

Led sayısı / Led number : 8

Renkler / Colors : 



Order Nr.  
Sipariş Kodu  
**11825**

Order Nr.  
Sipariş Kodu  
**11827**



## Flaşör Uyarı Lambaları ve Ledli Levhalar *Flasher Lamps & Led Displays*



Order Nr.  
Sipariş Kodu  
**11850**



Order Nr.  
Sipariş Kodu  
**11852**



### LEDLİ FLAŞÖR LAMBALAR

Malzeme / Material : PC

Ağırlık / Weight : 7,60 kg

Ebatlar / Size : (Ø) 30 cm



Order Nr.  
Sipariş Kodu  
**11860**



Order Nr.  
Sipariş Kodu  
**11862**



**ARAN**  
SAFETY

Order Nr.  
Sipariş Kodu  
**263900**

### ARAN SAFETY LEDLİ BUTON

Açıklama / Description : Ledli acil durum uyarı butonu / Flashing roadside emergency disc

Görünürlük / Visibility : 2 km

Mıknatıs / Magnetized : ✓

Askı / Hook : ✓

Led sayısı / Led number : 12 (Kırmızı / Red), 3 (Beyaz / White)

Yanma süresi / Running time : 38 saate kadar / Up to 38 hours



**10 Farklı Yanma Modu**  
**10 Different Flashing Modes**



Flaşör Uyarı Lambaları ve Ledli Levhalar *Flasher Lamps & Led Displays*

LEDLİ FLAŞÖR LAMBALAR



Order Nr.  
Sipariş Kodu  
**11838**



Order Nr.  
Sipariş Kodu  
**11836**



Order Nr.  
Sipariş Kodu  
**11835**



Order Nr.  
Sipariş Kodu  
**11844**



Order Nr.  
Sipariş Kodu  
**11842**



Order Nr.  
Sipariş Kodu  
**11839**



Order Nr.  
Sipariş Kodu  
**11848**



Order Nr.  
Sipariş Kodu  
**11847**



Order Nr.  
Sipariş Kodu  
**11846**



Order Nr.  
Sipariş Kodu  
**11831**



Order Nr.  
Sipariş Kodu  
**11832**



Order Nr.  
Sipariş Kodu  
**11833**

Malzeme / Material : PC

Ağırlık / Weight : 9,75 kg

Ebatlar / Size : 60 cm x 60 cm



## Trafik Levhaları Traffic Signs



Trafik Levhaları *Traffic Signs*



Ø 60 cm (Yuvarlak / Circular), 60 cm x 60 cm (Üçgen / Triangle), 50 cm x 60 cm (Dikdörtgen / Rectangular)





## Trafik Levhaları Traffic Signs



TR 073



TR 074



TR 075



TR 076



TR 077



TR 078



TR 079



TR 080



TR 081



TR 082



TR 083



TR 084



TR 085



TR 086



TR 087



TR 088



TR 089



TR 090



TR 091



TR 092



TR 093



TR 094



TR 095



TR 096



TR 154



TR 155



TR 156



TR 157



TR 158



TR 159



TR 160



TR 161



TR 162



TR 163



TR 164



TR 165



TR 166



TR 167

## Trafik Levhaları *Traffic Signs*



E

### VİDALI YUVARLAK LEVHA

Malzeme / Material : PVC Ebatlar / Size : (Ø) 28 cm

Order Nr.  
Sipariş Kodu  
**000237**



A



B



C



D

Order Nr.  
Sipariş Kodu  
**202341**

### VİDALI DİKTÖRTGEN LEVHA

Malzeme / Material : PVC

A



30 cm x (h) 30 cm

B



35 cm x (h) 41 cm

### VİDALI ÜÇGEN LEVHA

Malzeme / Material : PVC Ebatlar / Size : 39 cm

Order Nr.  
Sipariş Kodu  
**000251**



E



A



B



C



D





## Diğer Trafik Ekipmanları *Other Equipments*

Order Nr.  
Sipariş Kodu  
**217109**

### EMNİYET ALAN PERDESİ

Açıklama İnşaat alanını çevrelemek için yüksek görü-  
Description : nümlü plastik perde  
*This fence is highly visible and is ideal for all  
construction applications and many other uses*

Ebatlar / Size : 50 mt x (h) 1 mt

Renkler / Colors : 

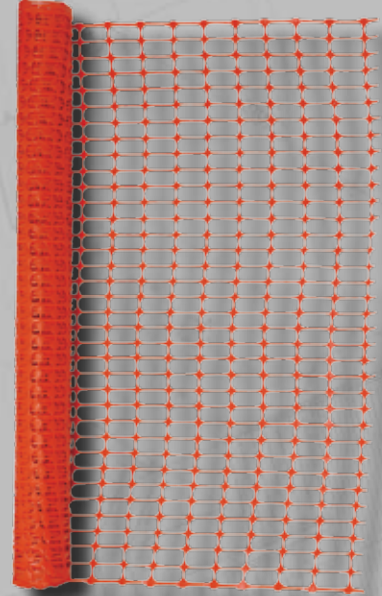



### İKAZ BANTI

Order Nr.  
Sipariş Kodu  
**211077**

Açıklama Hızlı çevreleme için PVC ikaz bantı  
Description : PVC tape for quick and simple barrier sets

Ebatlar / Size : 500 mt / 200 mt / 100 mt / 50 mt x (h) 80 mm

Renkler / Colors :  

12



Özel Baskı İmkani  
Personalised Printing Option



Düşük Metrajlı Rulolar  
Shorter Rolls Option



Diğer Trafik Ekipmanları *Other Equipments*



PLASTİK ZİNCİR

Order Nr.  
Sipariş Kodu  
215105

Açıklama Özel tasarımı ile birbirine kolay takılıp  
Description : çıkartılabilen parçalardan oluşan veya klasik  
sabit parçalı plastik zincir  
Plastic chain classic type or with  
adjustable pieces

Renkler / Colors :

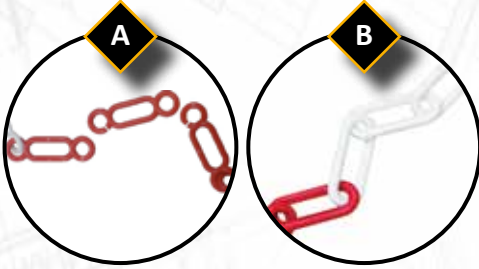

Order Nr.  
Sipariş Kodu  
218663

RÜZGAR GÜLÜ



Ebatlar / Size : (Ø) 40 cm x 210 cm

UYARICI BEZ BAYRAK

Order Nr.  
Sipariş Kodu  
210003

Reflektif Şeritler  
Reflective Lines



Ebatlar / Size : 40 cm x 28 cm



## Diğer Trafik Ekipmanları *Other Equipments*



### KOLON KÖŞE KORUYUCU

Order Nr.  
Sipariş Kodu  
**210006**

Malzeme / Material : PVC (B, C)  
PVC & PE (A)

Ağırlık / Weight : 1,90 kg (B, C)  
1,85 kg (A)

Ebatlar / Size : 7 cm x 12 cm x (h) 80 cm (B, C)  
9 cm x 14 cm x (h) 90 cm (A)

Reflektör / Reflective : ✓





Order Nr.  
Sipariş Kodu  
**217208**

### GÜVENLİK AYNASI

Malzeme / Material : PPC (A)  
ABS (B)

Ebatlar / Size : (Ø) 60 cm / (Ø) 80 cm (A)  
60 cm x 80 cm (B)

Renkler / Colors :  



Diğer Trafik Ekipmanları *Other Equipments*

Order Nr.  
Sipariş Kodu  
**076003**

**ARAÇ ALTI KONTROL AYNASI**



Fener / Lighting : ✓  
Tekerlekli / Wheels : ✓

Order Nr.  
Sipariş Kodu  
**172019**

**IŞIKLI COP**



Uzunluk / Length : 50 cm

Order Nr.  
Sipariş Kodu  
**218106**

**DUR-GEÇ LEVHASI**



Ebatlar / Size : (Ø) 20 cm

Order Nr.  
Sipariş Kodu  
**840055**

**ÜÇGEN REFLEKTÖR**



Ebatlar / Size : 40 cm







# HENES

G R O U P





# HENES

## G R O U P

Temsilcisi Olduğumuz Markalar  
*We Are Representing*

**ARAN**  
SAFETY  
Life is a Gift, Protect it!

**TEGERA**<sup>®</sup>

**B | BRAUN**

**ZEKLER**  
PROTECT YOUR SENSES

sorbent<sup>®</sup>

**jalas**  
FOR FEET WITH A TASK

**GUIDE**  
THE RIGHT GLOVES

**SARA**<sup>®</sup>

**mendi**

**TOF**<sup>®</sup>

**BICAP**<sup>®</sup>

**plum**

**Sundström**

**evelux**  
TECH

**cutwarder**

**elipse**

Tepecik Avenue Edincik Street. 5/8 Etiler/  
Istanbul /Turkey

[www.henesgrup.com](http://www.henesgrup.com)

Mob: +90 532 543 43 48

Phone: +90 212 801 37 57